

WORLD METEOROLOGICAL ORGANIZATION GLOBAL ATMOSPHERE WATCH

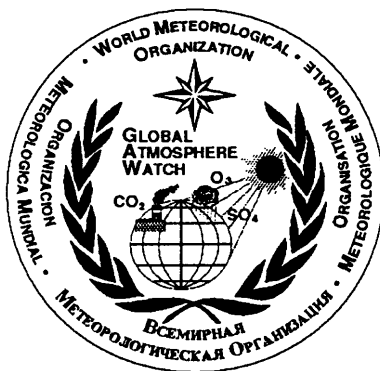

No. 130

Jülich Ozone Sonde Intercomparison Experiment (JOSIE)

5 February – 8 March 1996

by H.G.J. Smit and D. Kley



WMO TD No. 926

JOSIE

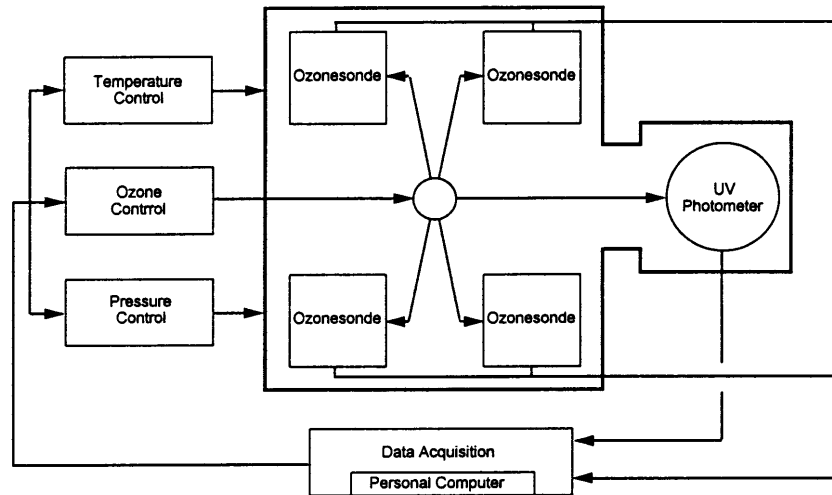

Jülich Ozone Sonde Intercomparison Experiment

The 1996 WMO International intercomparison of ozone sondes under quasi flight conditions in the environmental simulation chamber at Jülich

by

H.G.J. Smit and D. Kley

JOSIE: Executive Summary

The state of knowledge regarding long term trends of tropospheric as well as stratospheric ozone is limited due to inadequate global coverage of ozone sounding stations, poor assurance of data continuity and questionable homogeneity of data (WMO-Scientific Assessment of Ozone Depletion: 1994 ⁽¹⁾). Particularly, there is an urgent need for improved data quality which must be achieved by intercalibration and intercomparison of existing ozone sonde types as well as agreement through procedures for data processing and analysis (WMO-report No. 104, 1995 ⁽²⁾)

In order to assess the performance of the different types of ozone sondes used within GAW (=Global Atmosphere Watch) and GLONET (=Global Ozone Network) an international intercomparison experiment of ozone sondes, **JOSIE (=Jülich Ozone Sonde Intercomparison Experiment)** was conducted from 5 February to 8 March 1996 in the environmental simulation chamber of the World Calibration Facility for Ozone Sondes Calibration Facility (WCFOS) at the Forschungszentrum Jülich, Germany. A controlled environment plus the fact that the ozone sonde measurements could be compared to an accurate UV-Photometer as a reference experiments are essential elements for addressing questions that arise from previous field intercomparisons. JOSIE, sponsored by the WMO (=World Meteorological Organization) as part of QA/SAC (=Quality Assurance/Science Activity Centers)-program of GAW and hosted by the Forschungszentrum Jülich, was attended by eight ozone sounding laboratories from seven countries. The performance of four different ozone sonde types such as Electrochemical Concentration Cell (ECC) of two different manufacturers, Brewer/Mast (BM-original), Indian (modified BM-type) and Japanese (KC79), that are in routine operation in GAW/GLONET and additionally the prototype version of the Swiss BM-hybrid was assessed. Thus, all major types of ozone sondes were compared under controlled conditions.

In order to determine precision, accuracy and response of the ozone sondes as a function of sonde type, altitude, and ozone level, the different ozone sonde types were tested under a variety of conditions and compared with an accurate UV-photometer. Special attention was paid to the influence of pre-launch procedures on in-flight performance. In addition it was investigated how and how much the data analysis is affected by certain procedures such as background signal correction and total ozone column normalization.

All sondes tracked the simulated ozone profiles quite well within scale lengths larger than 200 m, even under extremely low ozone concentrations, as they occur in the tropical troposphere. Precision and accuracy are altitude dependent and varied in size for the different participating laboratories. For all sondes, the relative precision is best in the middle stratosphere. A best precision of $\pm(3-5)\%$ was achieved by the ECC-type ozone sondes. Conversely, the Non-ECC types of ozone sondes (Brewer-Mast, Indian and KC79), exhibited a somewhat lower precision of about $\pm(5-15)\%$. In the troposphere, the Non-ECC type sondes showed a somewhat lower precision compared to the ECC sondes.

¹ WMO (=World Meteorological Organization) , Scientific Assessment of Ozone Depletion: 1994, Global Ozone Research and Monitoring Project - Report No. 37, World Meteorological Organization, Geneva , 1995.

² WMO-Report No. 104: Report of the fourth WMO meeting of experts on the quality assurance/science activity centers (QA/SACs) of the global atmosphere watch. Jointly held with the first meeting of the coordinating committees of IGAC-GLONET and IGAC-ACE at Garmisch-Partenkirchen, Germany, 13-17 March 1995, WMO TD.No. 689, pp 10-12, 1995

Name [No.]	Participating Organization	Ozone Sonde Type
MOHp [1]	Meteorological Observatory Hohenpeissenberg, Germany	Brewer-Mast (original of Mast Comp.)
CMDL [2]	NOAA-Climate Monitoring & Diagnostic Laboratory, Boulder, USA	ECC/ENSCI-1Z (EN-SCI Corp.)
FZJ [3]	Forschungszentrum Jülich/ICG-2, Germany	ECC/SPC-6A(Science Pump Corp.)
IMD [4]	Indian Meteorological Department, Pune, India	Indian(Brewer-Mast type)
ASP [5]	Swiss Meteorological Institute / Aerological Station Payerne, Switzerland	Ozone Sensor: Brewer-Mast (original of Mast-Comp) Pump: Teflon (ENSCI Corp.)
AES [6]	Atmospheric Environmental Service, Ontario, Canada	ECC/SPC-5A(Science Pump Corp.), ECC/ENSCI-1Z (EN-SCI Corp.)
CNRS [7]	Centre Nationale de la Recherche Scientifique, Paris, France	ECC/SPC-5A (Science Pump Corp.)
JMA [8]	Japan Meteorology Agency, Tokyo, Japan	Japanese KC79 (MEISEI-Comp.)

Table: List of participating research institutions with the ozone sonde types used³

JOSIE showed that the ECC-type sondes perform best with regard to precision and accuracy if operated by the procedures described by Komhyr (1986) such that, in the troposphere and lower/middle stratosphere up to 35 km altitude, the precision is within $\pm(3-4)\%$ and the accuracy about $\pm(4-5)\%$. JOSIE showed that the different performance characteristics of the ECC-sondes (CMDL [2] and CNRS [7]) was caused by the use of different operating procedures. JOSIE clearly demonstrated that even a small change of the operating procedures can have a significant impact on the overall performance of the sonde and that caution has to be taken before any change of operating procedures of sondes.

The performance of the non-ECC type sondes showed in general higher variability and larger deviations from the UV-photometer measurements than the ECC and that the behavior of the different Non-ECC-sonde types is quite different. The original BM-sonde operated by MOHp exhibited a precision of about $\pm(3-5)\%$ and an accuracy of about $\pm 5\%$ in the stratosphere up to 30 km altitude while, in the troposphere, the precision was somewhat lower with values of about $\pm 10\%$ and the accuracy was $\pm(10-13)\%$. The BM-Hybrid/ASP gave good performance in the lower stratosphere (precision $\approx \pm 4\%$ and accuracy $\approx \pm 5\%$) up to 30 km. However, in the troposphere the sonde was suffering a low precision ($\approx \pm 18\%$) and low accuracy ($\approx \pm 33\%$). The KC79/JMA-sonde tended to underestimate ozone in the troposphere (precision $\approx \pm 6\%$ and accuracy $\approx \pm 10\%$) and lower stratosphere (precision $\approx \pm 5\%$ and accuracy $\approx \pm 10\%$)

³ Participants: H.G.J.Smit, W. Sträter, M. Helten, D. Ciupa, D. Kley [Forschungszentrum Jülich, Germany], H.J. Claude, U. Köhler, M. Adelwart [Deutscher Wetterdienst, Germany], B. Hoegger, G. Levrat, B. Henchoz [Swiss Meteorological Service, Switzerland], B. Johnson, S.J. Oltmans [NOAA-CMDL, U.S.A.], J.B. Kerr, D.W. Tarasick, J. Davies [Atmospheric Environments Service, Canada], M. Shitamichi, H. Kaneko [Japan Meteorological Agency], S.K. Srivastav, P.N. Mohanan [India Meteorological Department, India], C. Vialle, G. Velghe [Centre Nationale de la Recherche Scientifique, France]

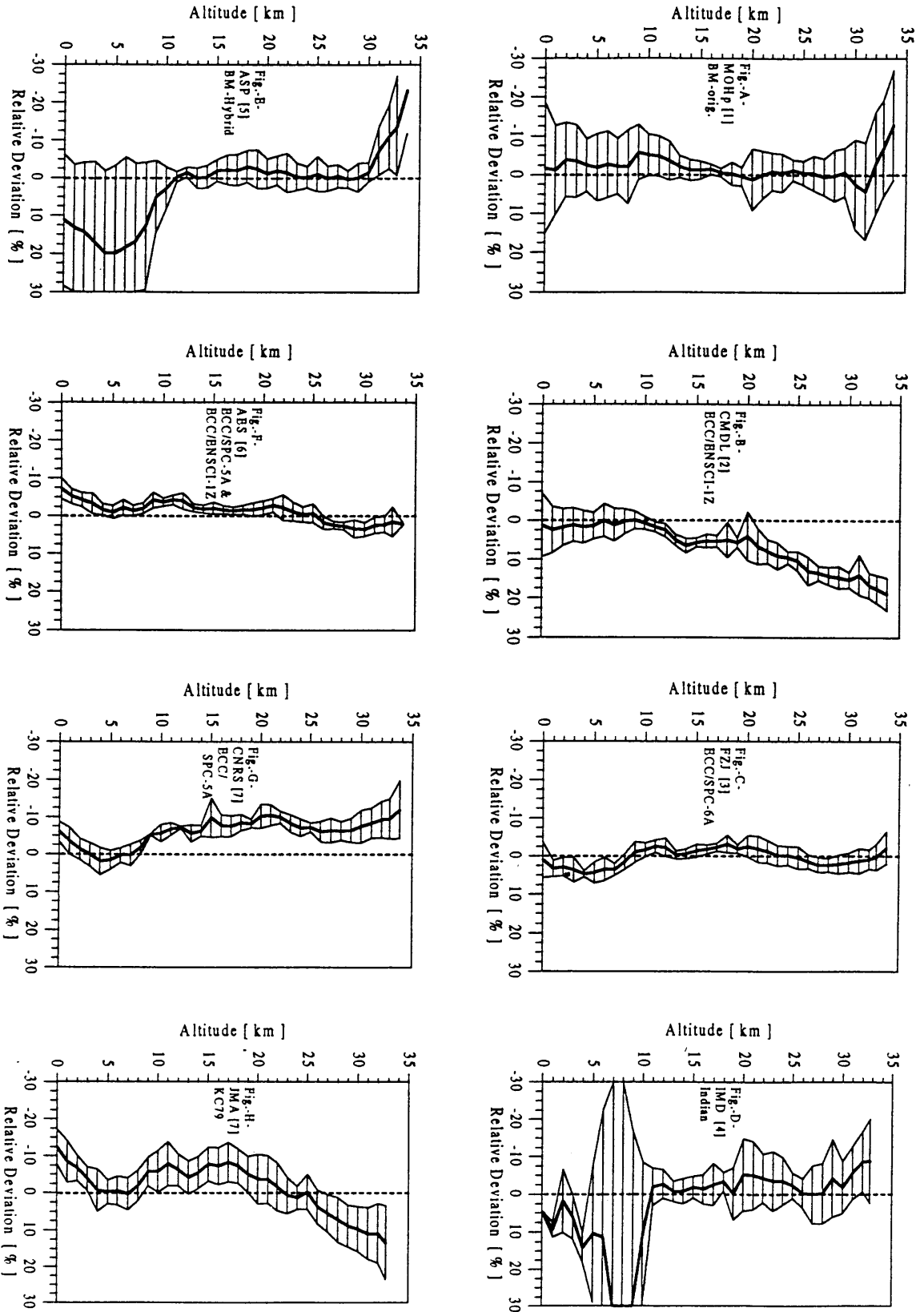

Summary of JOSIE-results: Average (thick line) plus/minus one standard deviation (thin line) of the relative deviations of the individual sonde readings from the UV-photometer for each participating sounding laboratory obtained from six simulation runs (4 mid-latitude + 2 tropical profiles). Tropospheric parts of tropical profiles below 20 km are excluded.

and to overestimate ozone above 25 km altitude (precision $\approx \pm 7\%$ and accuracy $\approx \pm(11-18)\%$) The Indian/IMD sonde showed a precision of about $\pm(4-8)\%$ and an accuracy $\pm(6-13)\%$ in the lower stratosphere, with decaying performance above 30 km altitude. In the troposphere the sonde showed strong fluctuations and deviations from the UV-photometer.

Although all individual normalization factors range between 0.9 and 1.1, the variability (standard deviation) of the ECC-sonde types with values of ± 0.02 for three of the four ECC-stations is significantly smaller than the variability of the other types of sondes, at values of $\pm(0.07-0.10)$. The normalization factors for the Non-ECC-type sondes are closer to unity than usually achieved during field operation at the sounding site.

The observed larger variability among ozone sonde measurements in the middle stratosphere is mainly caused by uncertainties in the pump efficiency and by the amount of evaporating sensing solution. Significant differences (more than 5-10 % at 5 hPa) were observed between the various experimental methods used to determine the pump flow efficiency at lower pressures. JOSIE indicated that the sensitivity of the ECC-sonde increases during flight due to evaporation caused changes of the concentrations of the sensing solutions. However, the process is not understood in detail and more investigations are necessary to study this effect, particularly in relation to the initial concentrations of the sensing solutions, the actual temperature of the sensing solution and the pump flow efficiency correction which also has an important influence on the sonde performance.

The determination of tropospheric ozone profiles by ozone sonde measurements is sensitive to the methods of background/offset signal processing. This point, being of general importance, becomes critically important for the measurement of tropical ozone profiles. A strong recommendation for further research is to get a better understanding on the origin and evolution of the background signals during flight.

The JOSIE-results show that the achievement of good precision and high accuracy is strongly dependent on sonde type and handling. Non-ECC types need more preparation efforts to obtain results similar to those from well prepared ECC-sondes. The observed differences between the ECC-sonde types are mostly due to differences in the preparation and correction procedures applied by the different laboratories. JOSIE clearly demonstrates that there is an urgent need for the homogenization of the standard operating procedures (SOP) for pre-launch preparation and post-flight data processing. Further, there is a need for research to get a more fundamental understanding of the influences of instrumental factors such as background signal, sensing solution, pump flow efficiency and their uncertainties on the data quality of ozone soundings. In addition, the use of the total ozone normalization as a correction factor has to be re-evaluated for the tropospheric as well as for the stratospheric part of the measured ozone profile.

JOSIE brought valuable information about the performance of the different ozone sonde types and the influence of the operating procedures for preparation and data correction applied by the participating laboratories. JOSIE showed also that there is a need to validate ozone sondes on a routine basis. Ozone sondes have gone through some modifications since they were first manufactured, which adds uncertainty to trend analysis. Routine testing of newly manufactured ozone sondes on a regular basis, following a standard operating procedure, will help to ensure more confidence in observed trends in the future. A pre-requisite thereby is the standardization of the preparation procedures and data correcting methods in the near future, but also a better and more detailed documentation of the procedures and methods applied in the past at the different long term ozone sounding stations.

Preface

The main driving force of global atmospheric observations and atmospheric chemistry research is the need to develop sound environmental policy related to the following questions: What is the effect of human activity on stratospheric and tropospheric ozone? How is the UV flux at the surface of the Earth changing in response to changes in the ozone column density? How is surface climate sensitive to the atmospheric concentrations of greenhouse gases and aerosols, and what factors control these concentrations? How is the oxidizing power of the atmosphere changing with time, and what is the influence of human activity? How is regional air quality degraded by industrial and other anthropogenic emissions in populated areas of the world?

The answers to these questions are provided--in part--by WMO-GAW and IGAC-GLONET, and the resulting data sets are used by policy makers to resolve major scientific issues. It is therefore imperative that all data be obtained by strict adherence to comprehensive quality assurance programmes. The Quality Assurance/Science Activity Centres (QA/SACs) design and execute these quality assurance programs.

The Global Atmosphere Watch (GAW) program is a coordinated network of observing stations, associated facilities and infrastructure encompassing measurement and related scientific assessment activities. The overall role of GAW is to supply basic information of known quality indicative of the atmospheric environment that transcends specific issues (Global Atmosphere Watch Guide, GAW Report No. 86, 1993).

The state of knowledge regarding long term trends of tropospheric as well as stratospheric ozone is limited due to a limited global coverage of ozone sounding stations, poor assurance of continuity of data and questionable homogeneity of data (WMO Scientific Assessment of Ozone Depletion, 1995). Particularly, there is an urgent need for improved data quality which must be achieved by intercalibration and intercomparison of existing ozone sonde types as well as agreement on procedures for data processing and analysis (WMO-Report No. 104, 1995).

Despite the fact that during previous series of WMO-intercomparisons in the field (Attmanspacher et al., 1970, 1981, and Kerr et al., 1994), where several different types of ozone sondes were simultaneously flown, many questions with regard to the observed instrumental performance of the different ozone sondes were left unanswered. A key shortcoming was that in most intercomparisons no ozone reference standard was simultaneously flown. Several national and international efforts are underway towards building a representative global network of ozone sonde stations. WMO-GAW and IGAC-GLONET are committed to support such efforts. However, prior to any expansion, and in order to optimize the use of existing networks for accurate measurements of tropospheric O₃ profiles, it is absolutely essential that certain tasks be accomplished: Intercalibration and intercomparison of existing ozone sonde types; Agreement on measurement frequency and timing; Agreement on procedures for data processing and analysis. The short-term objectives of this task are: (1) to bring together from around the world scientists from the current ozone sonde measurement programs, and (2) to compare instrument performance in a controlled environment and, thus, determine the accuracy and other characteristics influencing data comparability of the field instruments. The long-term objective is to establish a permanent facility for ozone sonde intercomparison and calibration.

The Jülich Ozone Sonde Intercomparison Experiment (JOSIE-1) performed in 1996 is the first GAW-GLONET activity towards implementing a global quality assurance plan for ozone

sondes in routine use today around the world. Considerable credit must be conferred on Prof. Volker Mohnen who conceived and promoted this experiment. Further recognition must be given to Dr. Herman Smit and Prof. Dieter Kley for organizing and carrying out JOSIE 1. The participants⁽⁴⁾ are also to be congratulated for their active part in making the experiment a success.

⁴ *H.G.J.Smit, W. Sträter, M. Helten, D. Ciupa, D. Kley [Forschungszentrum Jülich, Germany], H.J. Claude, U. Köhler, M. Adelwart [Deutscher Wetterdienst, Germany], B. Hoegger, G. Levrat, B. Henchoz [Swiss Meteorological Service, Switzerland], B. Johnson, S.J. Oltmans [NOAA-CMDL, U.S.A.], J.B. Kerr, D.W. Tarasick, J. Davies [Atmospheric Environments Service, Canada], M. Shitamichi, H. Kaneko [Japan Meteorological Agency], S.K. Srivastav, P.N. Mohanan [India Meteorological Department, India], C. Vialle, G. Velghe [Centre Nationale de la Recherche Scientifique, France]*

Table of Contents

JOSIE: Executive Summary.....	i
Preface.....	v
1. Introduction.....	1
2. Ozone Sondes.....	3
2.1 Introduction.....	3
2.2 Principle of Operation.....	3
2.3 Brewer Mast Ozone Sonde (BM).....	3
2.4 Electrochemical Concentration Cell Ozone Sonde (ECC).....	6
2.5 Japanese Ozone Sonde (KC79).....	8
3. Technical Description of World Calibration Facility for Ozone Sondes (WCFOS).....	9
3.1 Set Up of the Facility.....	9
3.2 Environmental Simulation Chamber	10
3.3 Ozone Profile Simulator	11
3.4 Ozone Reference: Dual Beam UV-Photometer	11
3.5 Data Acquisition System	11
4. Experimental Details.....	12
4.1 Introduction.....	12
4.2 Simulated Profiles of Pressure, Temperature and Ozone.....	12
4.3 Data Acquisition.....	13
4.4 Ozone Sonde Data Processing.....	13
4.4.1 Basic Operating Formulas.....	13
4.4.2 Temperature of Gas Sampling.....	15
4.4.3 Pump Flow Efficiency Correction.....	15
4.4.4 Background Correction.....	16
4.4.5 Total Ozone Normalization.....	16
4.5 Formal Agreement and Data Protocol.....	16
4.6 Data Submission.....	16
4.7 Data Evaluation.....	17

5.	Results and Discussion	17
5.1	Introduction.....	17
5.2	Individual Simulation Runs.....	18
5.2.1	Introduction.....	18
5.2.2	Total Ozone Normalization as Screening Test.....	18
5.2.3	Special Case: Tropospheric Profiles in the Tropics.....	19
5.2.4	In-Flight Time Response.....	21
5.3	Comparison Sondes With UV-Photometer.....	23
5.3.1	Introduction.....	23
5.3.2	Striking Features About Performance Characteristics of Different Sondes.....	26
5.3.3	Precision, Bias and Accuracy.....	28
5.4	Comparison JOSIE With Other Intercomparison Campaigns.....	33
5.4.1	Introduction.....	33
5.4.2	Comparison in the Stratosphere.....	33
5.4.3	Comparison in the Troposphere.....	34
6.	Conclusions	34

Acknowledgment

References

Appendix

- A. Results of Individual Simulation Runs of Each Participating Laboratory
- B. Specifications of JOSIE-Data
- C. People Involved in JOSIE
- D. Formal Agreement of JOSIE
- E. Data Protocol of JOSIE

1. Introduction

Several different ozone sonde types were simultaneously flown during previous WMO-intercomparisons in the field (Attmanspacher et al., 1970, 1981, and Kerr et al., 1994). However, questions with regard to the observed instrumental performance of the different ozone sondes were left unanswered. A key shortcoming of these previous intercomparisons is that no accurate ozone reference instrument was simultaneously flown. The environmental simulation chamber of at Forschungszentrum Jülich enables control of pressure, temperature and ozone concentration and can simulate flight conditions of ozone soundings up to an altitude of 35 km. The controlled environment plus the fact that the ozone sonde measurements can be compared to an accurate UV-Photometer as reference (Proffitt et al., 1983, Smit et al. 1994) allows to conduct experiments that are designed to address questions which arose from previous field intercomparisons.

During the fourth WMO meeting of experts on the QA/SACs (=Quality Assurance and Science Activity Centers) of the GAW (=Global Atmosphere Watch) at Garmisch-Partenkirchen (Germany) in March 1995 (WMO-report No. 104, 1995) it was decided to establish and to designate the environmental simulation chamber at Forschungszentrum Jülich as World Calibration Facility for Ozone Sondes (=WCFOS): a facility for quality assurance of ozone sondes used in GAW/GLONET focusing on ozone sonde precision, accuracy and long term stability. A WMO sponsored international intercomparison experiment of ozone sondes, **JOSIE =Jülich Ozone Sonde Intercomparison Experiment**, was conducted from 5 February to 8 March 1996 in the environmental simulation chamber of the World Calibration Center for Ozone Sondes. The aim was to assess the performance of the major types of ozone sondes that are in use used within GAW (=Global Atmosphere Watch) and GLONET (=Global Ozone Network). JOSIE, sponsored by WMO (=World Meteorological Organization) as part of QA/SAC (=Quality Assurance/Science Activity Centers)-program of GAW and hosted by Forschungszentrum Jülich, was attended by eight ozone laboratories from seven countries. This was the first time that all major types of ozone sondes were compared under controlled conditions.

The participating institutions, listed in Table 1, were split into two groups of four teams. Both groups attended the campaign for a two weeks period: 5 to 16 February (Campaign C-I) or 26 February to 8 March 1996 (Campaign C-II). The participating teams represented the major types of operational ozone sondes within the sounding programs of GAW/GLONET. The performance of four different ozone sonde types such as Electrochemical Concentration Cell (ECC) of two different manufacturers, Brewer/Mast (BM-original), Indian (modified BM-type) and Japanese (KC79), that are in routine operation in GAW/GLONET and additionally the prototype version of the Swiss BM-hybrid was assessed. Three different models of the ECC-type were used: the SPC-5A and SPC-6A models of Science Pump Corporation and the ENSCI-1Z-model of EN-SCI-Corporation. Brewer-Mast types of ozone sondes were represented by the original model of the Mast-Company as well as the Swiss BM-hybrid of an ozone sensor from Mast-Company coupled with a Teflon pump from EN-SCI Corporation. The Indian sonde is a Brewer-Mast like ozone sensor with a Teflon pump manufactured by the Indian Meteorological Department. The Japanese sonde is the KC79 manufactured by MEISEI-Company.

Name [Number]	Participating Organization	Ozone Sonde Type
MOHp [1]	Meteorological Observatory Hohenpeissenberg, Germany	Brewer-Mast (original of Mast Comp.)
CMDL [2]	NOAA-Climate Monitoring & Diagnostic Laboratory, Boulder, USA	ECC/ENSCI-1Z (EN-SCI Corp.)
FZJ [3]	Forschungszentrum Jülich/ICG-2, Germany	ECC/SPC-6A (Science Pump Corp.)
IMD [4]	Indian Meteorological Department, Pune, India	Indian (Brewer-Mast type)
ASP [5]	Swiss Meteorological Institute / Aerological Station Payerne, Switzerland	Ozone Sensor: Brewer-Mast (original of Mast-Comp) Pump: Teflon (ENSCI Corp.)
AES [6]	Atmospheric Environmental Service, Ontario, Canada	ECC/SPC-5A [4 sondes] (Science Pump Corp.), ECC/ENSCI-1Z [2 sondes] (EN-SCI Corp.)
CNRS [7]	Centre Nationale de la Recherche Scientifique, Paris, France	ECC/SPC-5A (Science Pump Corp.)
JMA [8]	Japan Meteorology Agency, Tokyo, Japan	Japanese RSII-KC79 (MEISEI-Comp.)

Table 1: List of participating research institutions with the ozone sonde types used

The major goal of JOSIE was to investigate the precision, accuracy and response of the different ozone sonde types under controlled laboratory conditions as a function of altitude and ozone level. Special attention was paid to the influences of pre-launch procedures on in-flight performance, and to data analysis procedures such as background signal correction and total ozone column normalization. An additional, important objective was to develop and update Standard Operating Procedures (SOP's) for different ozone sonde types, including pre-flight preparations and post-flight data reduction. The results of JOSIE were discussed and evaluated by all eight participating laboratories at the Meteorological Observatory Hohenpeissenberg (MOHp), Germany, 24-27 February 1997 ⁽⁵⁾. In this report we present the final results of the JOSIE-campaign.

⁵ Combined WMO/GAW-Workshop of JOSIE-Results/Standard Operation Procedures and SPARC/IOC-Evaluation of Data Quality of Ozone Sondes for Trend Assessment, at Meteorological Observatory Hohenpeissenberg (MOHp), Germany, 24-27 February 1997, sponsored by WMO and hosted by the German Weather Service (DWD).

2. Ozone Sondes

2.1 Introduction

Ozone sondes are small, lightweight and compact balloon borne instruments, developed for measuring the vertical distribution of atmospheric ozone up to an altitude of about 35-40 km. During normal flight operation, ozone sondes are coupled via special interfacing electronics with radiosondes for data transmission and additional measurement of meteorological parameters like pressure, temperature (optional humidity and wind). Total weight of the flight package is about 1 kg which can be flown on weather balloons. The data measured by the sonde is telemetered to the ground station for further data processing. However, JOSIE focused exclusively on the instrumental performance of the different ozone sensors under controlled laboratory conditions such that the different types of radiosondes with their interfacing electronics were excluded from the intercomparison and are beyond the scope of this report. In this section the different ozone sondes and their major differences are briefly described.

2.2 Principle of Operation

The principle of ozone measurement of the sonde types participating in JOSIE (see Table 1) is based on the titration of ozone in a potassium iodide (KI) sensing solution according the redox reaction ⁽⁶⁾:



The amount of generated „free“ iodine (I_2) is measured in electrochemical reaction cell(s). Continuous operation is achieved by a small electrically driven gas sampling pump which forces ambient air through the sensing solution of the electrochemical cell. Transported by the stirring action of the air bubbles, the iodine makes contact with a platinum cathode and is reduced back to iodide ions by the uptake of 2 electrons per molecule of iodine.



An electrical current proportional to the mass flow rate of ozone through the cell is generated. In principle, this type of electrochemical ozone sensor is an absolute measuring device. By knowing the gas volumetric pumping rate and the gas temperature the measured electrical current is converted to the ozone concentration in the sampled ambient air. However, the layout of the electrochemical ozone sensors of the different sonde types listed in table 1 have significant differences which are described briefly in this section.

2.3 Brewer Mast Ozone Sonde (BM)

The Brewer-Mast sonde has evolved from the Oxford-Kew ozone sonde developed by Brewer and Milford (1960). The Brewer-Milford type ozone sensor consist of a single electrochemical cell with a silver anode and platinum cathode immersed in an alkaline potassium iodide solution. A polarizing potential of 0.41 V is applied between the electrodes such that no current will flow unless free iodine is present. In operation, ozone in the sampled ambient air is forced through the sensing solution in the electrochemical cell (bubbler) to produce free iodine according redox reaction R-1. At the surface of the Pt-cathode, I_2 will be converted to I^- through the uptake of two electrons [R-2], while at the anode surface two electrons are released through the ionization of two silver atoms

⁶ An exception is the Japanese KC79-ozone sensor which uses potassium bromide (KBr) instead of potassium iodide (KI). However, the principle of operation via a reaction mechanism similar to the redox reaction [R1] and cathode reaction [R2] is not different compared to the other types of electrochemical sondes used in JOSIE.

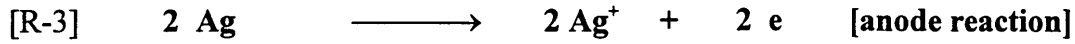

to form the insoluble silver iodide.

In principle, each ozone molecule entering the sensor causes a current of two electrons to flow through the external circuit. The original Brewer-Mast ozone sonde (Type 730-10), and two hybrid types, ASP-hybrid sonde and Indian sonde, participated in JOSIE.

[A] Original Brewer Mast Ozone Sonde (Type 730-10):

The original Brewer Mast ozone sonde is manufactured by Mast Keystone Corporation in Reno, Nevada, USA. The most recent version (type 730-10) had been used by the Meteorological Observatory Hohenpeissenberg (MOHp) during the first part of the JOSIE-campaign. A schematic diagram is shown in Figure 1-A. The reaction chamber (bubbler) is made of Plexiglas and contains a cylindrical platinum mesh cathode ($\approx 6 \text{ cm}^2$) and a thin silver wire as anode. The bubbler is filled with 2 ml of neutrally buffered aqueous solution of potassium iodide (0.1%). The electrically driven gas sampling pump is mounted at the right side of the bubbler and forces about $220 \text{ cm}^3/\text{min}$ of ambient air through the bubbler. The sonde is protected by a Styrofoam flight box.

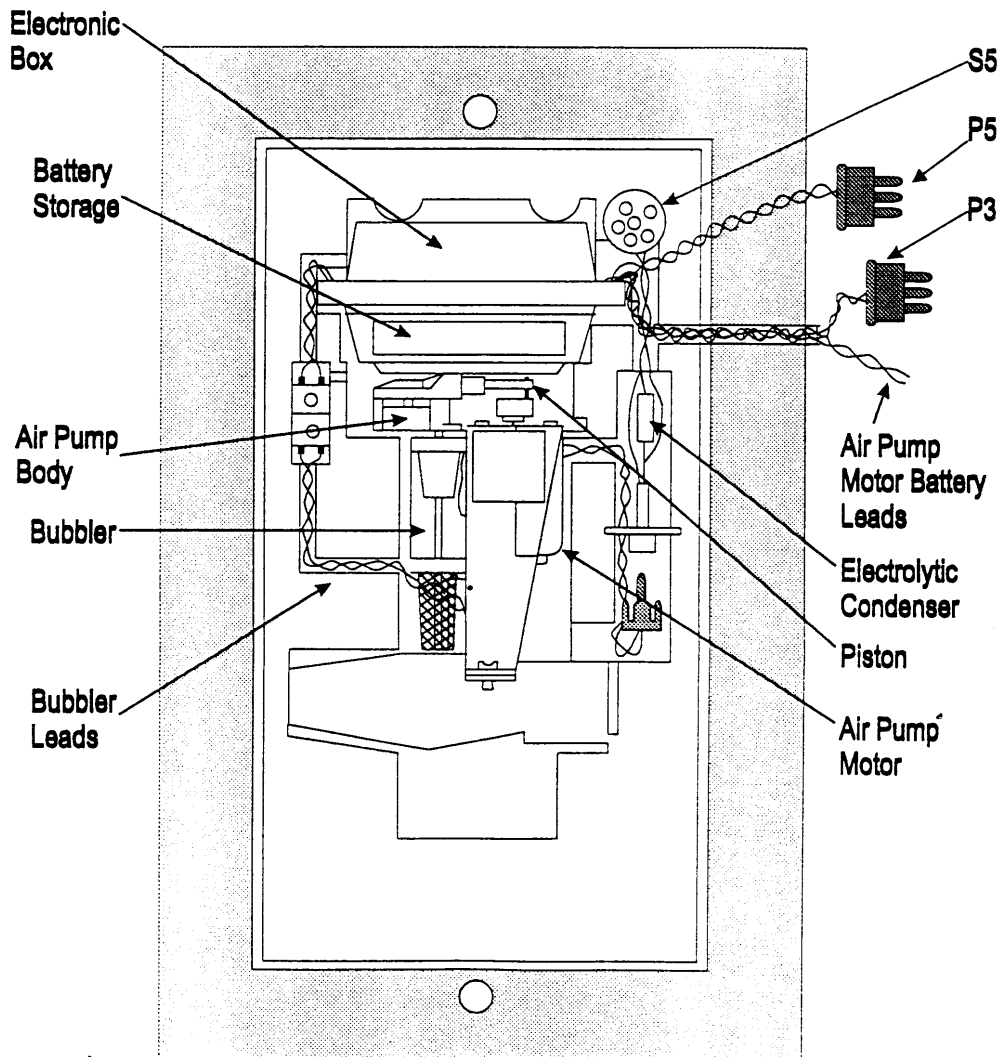

Figure 1-A: Brewer-Mast (original), model type 730-10 (after Müller, 1976)

[B] *ASP-hybrid of Brewer-Mast Ozone Sonde:*

The sonde used in JOSIE by the group of the Aerological Station Payerne (ASP) is a modification of the Brewer-Mast sonde type 730-10 (Mast-Keystone Corporation, Reno, Nevada, USA) by employing the non-reactive Teflon pump of ECC-sondes (motor/pump assembly by EN-SCI-Corporation, Boulder, CO, USA). The schematics of this hybrid type of sonde is shown in Figure 1-B. The ozone sonde is packed together with its interfacing electronics in a separate compartment of a Styrofoam box which usually contains also the meteorological radiosonde. The bubbler is filled with 2 ml of neutrally buffered aqueous solution of potassium iodide (0.1%). The electrically driven gas sampling pump is mounted at the right side of the bubbler and forces about 220 cm³/min of ambient air through the bubbler. The hybrid Brewer-Mast sonde has been developed to investigate the influence of the gas-sampling pump on the performance characteristics of the Brewer-Mast sensor. It is noted that usually, during long term field operation at the Payerne sounding station, the original Brewer-Mast ozone sonde has been flown.

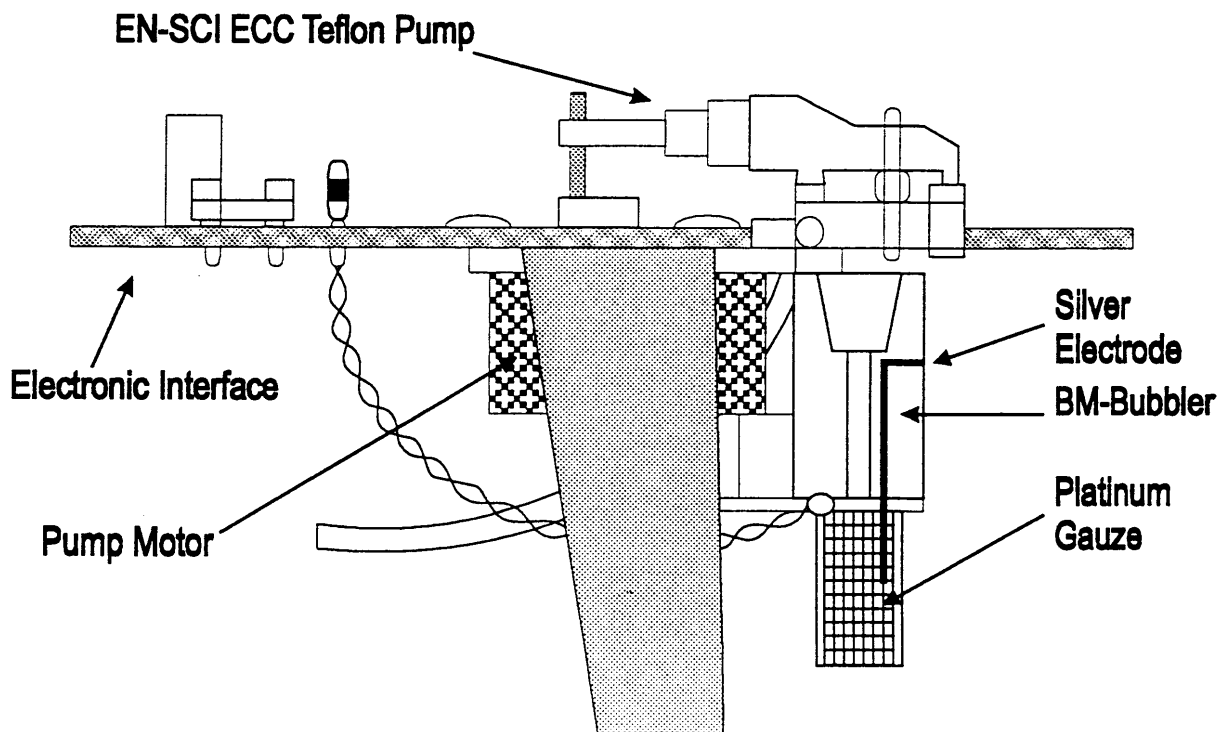

Figure 1-B: *Prototype version of ASP-hybride of Brewer-Mast sonde*

[C] *Indian Ozone Sonde:*

Indian ozone sonde is a hybrid of a Brewer-Milford type ozone sensor made of Plexiglas and a non-reactive Teflon pump. All parts of the sonde are manufactured and assembled by the Indian Meteorological Department. The sonde is mounted in a polystyrene flight box. A schematic diagram of the sonde is shown in Figure 1-C. Typical flow rate of the gas sampling is about 200 cm³/min. The anode is a silver wire (length \approx 5cm, $\phi \approx$ 0.5 mm) and the cathode a cylindrical Pt-gauze (3 cm²) immersed in a neutrally buffered aqueous KI-solution (0.25 %).

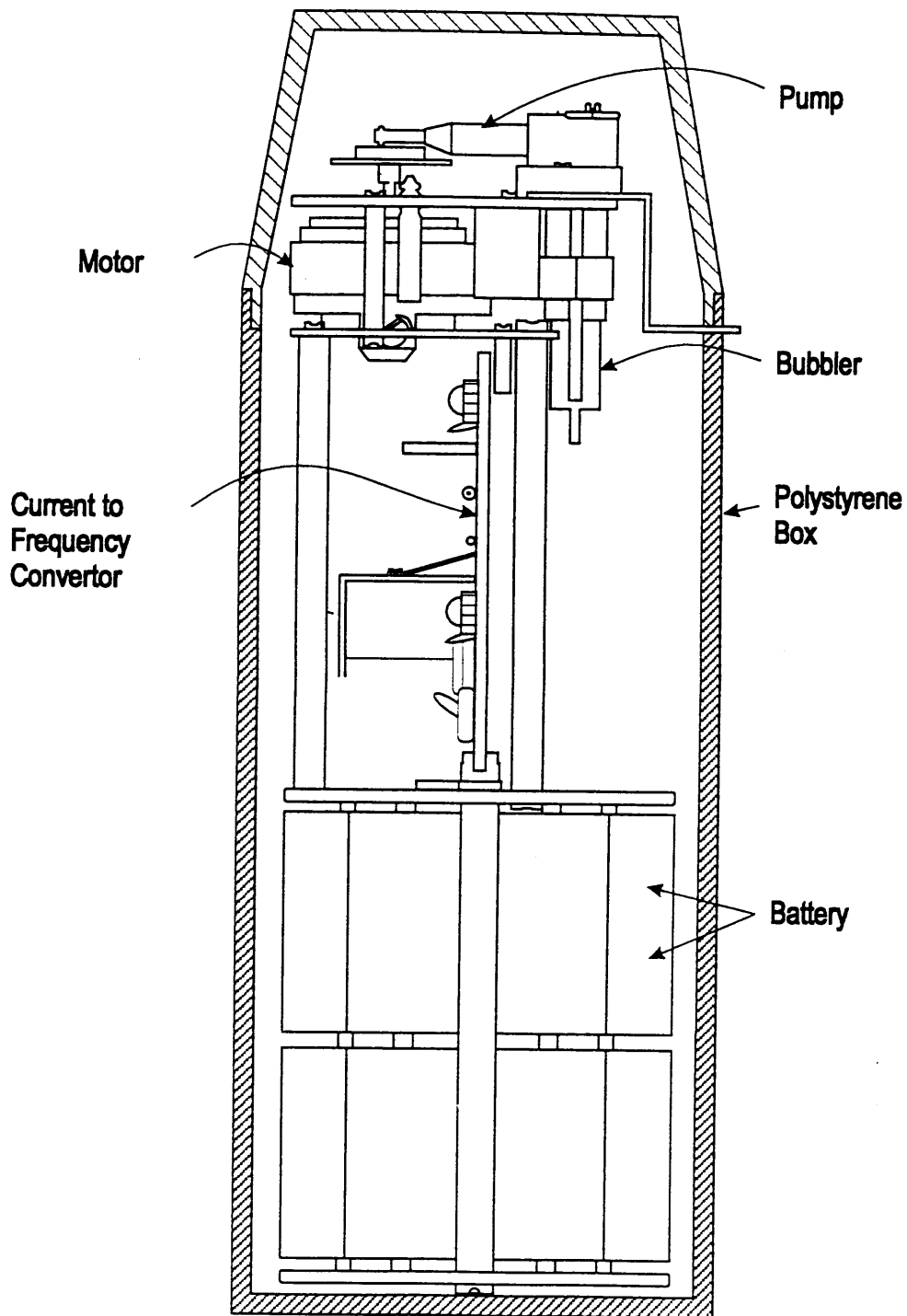

Figure 1-C: Indian ozonesonde

2.4 Electrochemical Concentration Cell Ozone Sonde (ECC)

The ECC (=Electrochemical Concentration Cell) ozone sonde was developed by Komhyr (1969, 1971). The ECC-ozone sensor is an electrochemical cell consisting of two half cells, made of Teflon, which serve as cathode and anode chamber, respectively. Both half cells contain platinum mesh electrodes. They are immersed in a KI-solution of different concentrations. The two chambers are linked together by an ion bridge in order to provide an ion pathway and to prevent mixing of the cathode- and anode electrolytes.

The ECC sensors do not require an external electrical potential. This is in contrast to the Brewer-Milford type of electrochemical ozone sensor [Brewer et al., 1960]. The ECC gets its driving electromagnetic force from the difference in the concentration of the KI-solution in the cathode- and anode chamber, 0.06 Mol/l (=1% KI) and ≈ 8.0 Mol/l (KI-saturated) respectively. A non-reactive Teflon gas sampling pump (Komhyr, 1967) forces ozone in ambient air through the cathode cell with the lower concentrated KI-sensing solution and causes an increase of „free“ iodine (I_2) according the redox reaction [R-1]. At the surface of the Pt-cathode, I_2 will be converted to I^- through the uptake of two electrons [R-2], while at the anode surface, I^- is converted to I_2 through the release of two electrons, such that the overall cell reaction is



Thereby one ozone molecule causes two electrons to flow in the external circuit. The electrical current is thus directly related to the uptake rate of ozone in the cathode chamber. The schematics of the ECC-ozone sonde is displayed in Figure 1-D. The Instrument, size about 8x8x14 cm, is enclosed in a polystyrene flight box ($\approx 19 \times 19 \times 25$ cm).

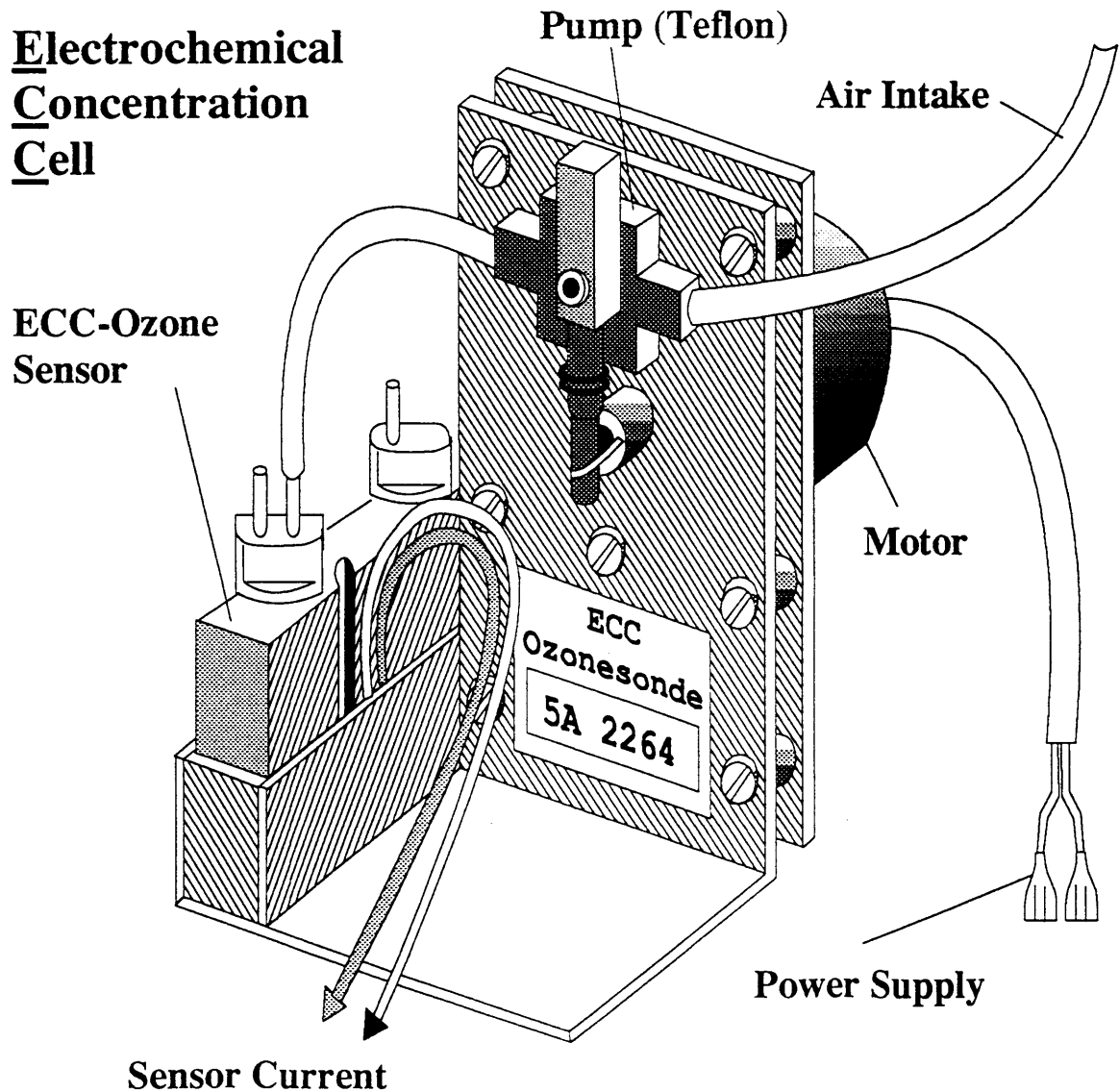
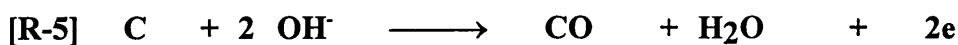

Figure 1-D: Electrochemical Concentration Cell (SPC-5A, SPC-6A and ENSCI-IZ, after Komhyr, 1969)

Three different models of the ECC-type were used: the SPC-5A (former ECC-5A) and SPC-6A models manufactured by Science Pump Corporation (Camden, New Jersey, USA) and the ENSCI-1Z-model manufactured by EN-SCI Corporation (Boulder, CO, USA).

2.5 Japanese Ozone Sonde (KC79)

The KC79-ozone sonde type is a modified version of the KC68-sonde type developed by Kobayashi and Toyama (1966). Both sonde types are based on the carbon-iodine ozone sensor type (Komhyr, 1965). The ozone sensor is a single electrochemical cell containing a platinum gauze as cathode and an activated carbon anode immersed in an aqueous neutral potassium bromide solution. Ozone in ambient air is forced through the sensing solution generating „free“ bromine molecules (Br_2) similar like the redox-reaction R-1. At the Pt-cathode the bromine is reconverted into bromide (Br^- -ions) by the uptake of two electrons, while correspondingly at the activated carbon anode under the release of two electrons following reaction takes place:



Accordingly, one ozone molecule produces an electrical current of two electrons in the external circuit.

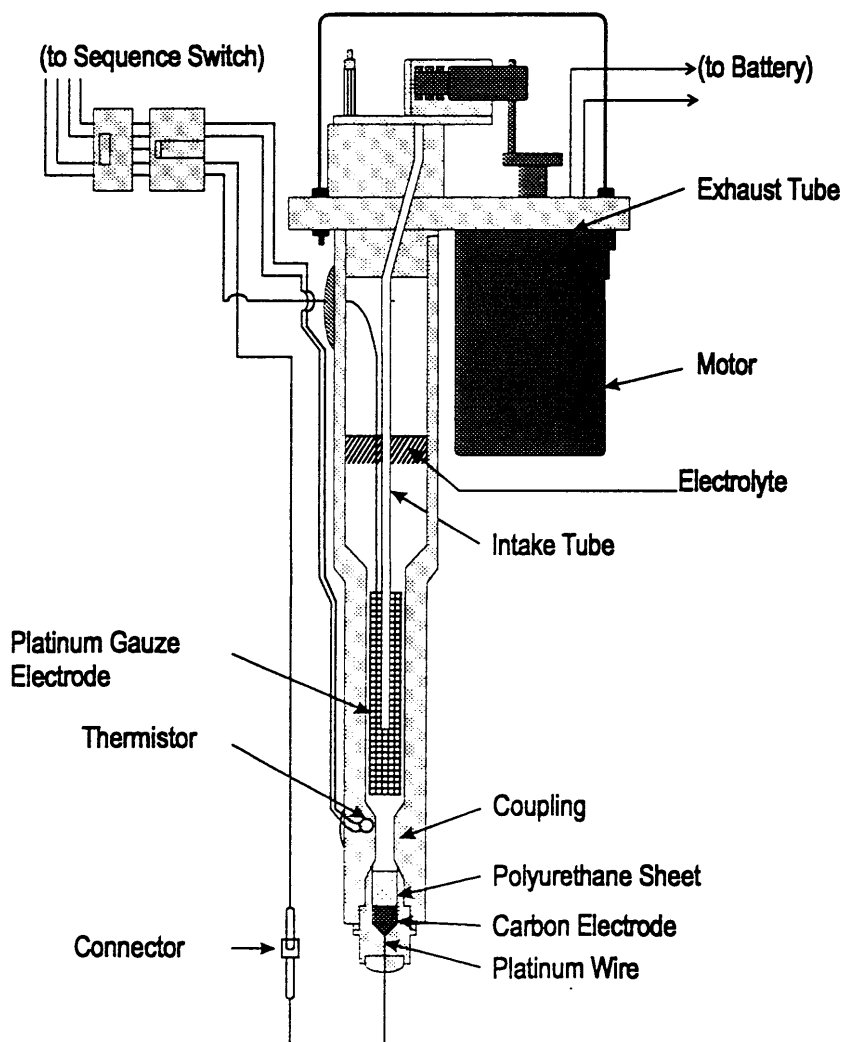

Figure 1-E: Japanese RSII-KC79 ozonesonde

The schematics of the sonde is shown in Figure 1-E. The gas sampling pump and the electrochemical cell are made of methacrylate resin. The pump flow rate is about 400 cm³/min with the pump motor speed being held constant by a governor. The sonde is enclosed in a Styrofoam flight box. The RSII-KC79 sonde is manufactured by Meisei Electric Company, Ibaraki, Japan

3. Technical Description of World Calibration Facility for Ozone Sondes (WCFOS)

3.1 Set Up of the Facility

The ozone sonde calibration facility had been established at Jülich for testing, calibrating and comparison of the different types of balloon borne ozone sondes which are used world wide for measuring the vertical distribution of ozone in the troposphere and lower/middle stratosphere (Smit et al., 1994).

The experimental set up of the simulation facility, shown in Figure 2, consists of the following major components:

1. Temperature controlled vacuum chamber as environmental simulation chamber
2. Fast response dual beam UV-photometer as ozone reference.
3. Ozone profile simulator, a gas flowing system to provide simultaneously four ozone sondes plus UV-photometer with ozone concentrations according simulated vertical ozone profiles.
4. Computer controlled data acquisition system for automatic control of the simulation process as well as post-flight data processing.

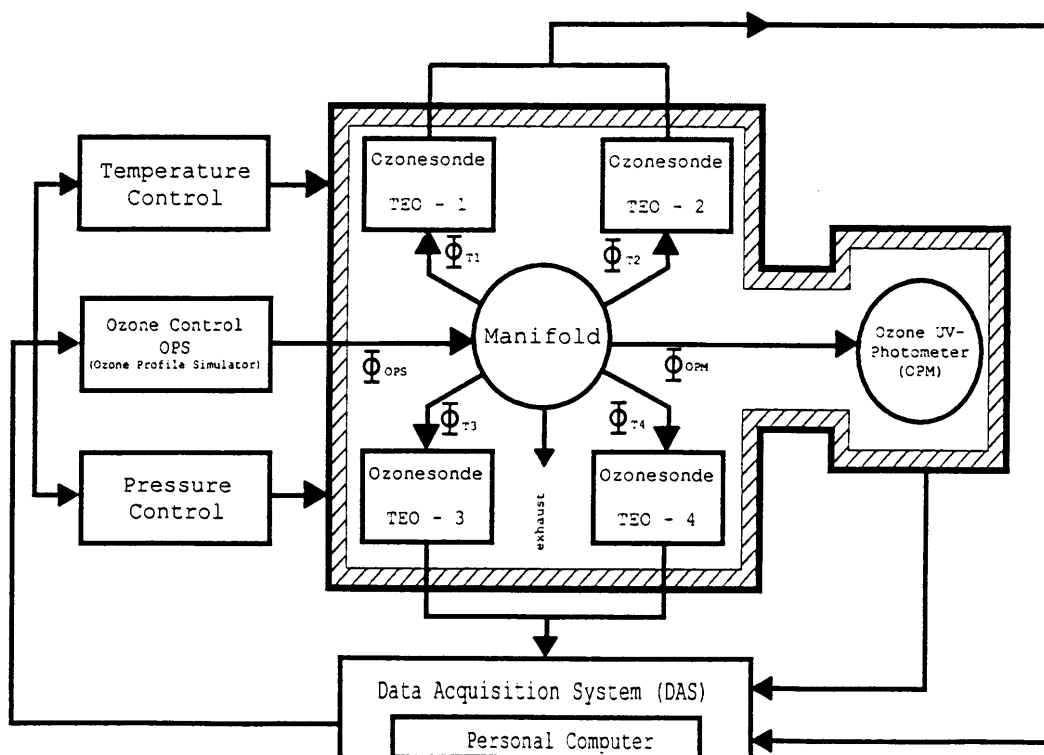

Figure 2: Schematics of the experimental set-up for the simulation of vertical ozone soundings

Four ozone sondes can be „flown“ simultaneously and compared to the UV-Photometer. Different types of vertical profiles of pressure, temperature and ozone concentrations versus time can be simulated according vertical soundings with ascent velocities of about 5 m/s. The major components of the facility are briefly described in this section. A detailed technical description of the facility is reported by Smit et al. (1998)

3.2 Environmental Simulation Chamber

The environmental simulation chamber, shown in Figure 3, is a vacuum chamber with a test room volume of about 500 liter (80x80x80 cm) whereby pressure as well as temperature can be dynamically regulated between 5 and 1000 hPa and between 200 and 300 K, at rates $-2\text{K/min} \leq \text{rate} \leq +2\text{K/min}$. Isothermally operated, the temperatures of the air as well as the wall inside the test room can be regulated and kept constant to within $\pm 0.2\text{ K}$.

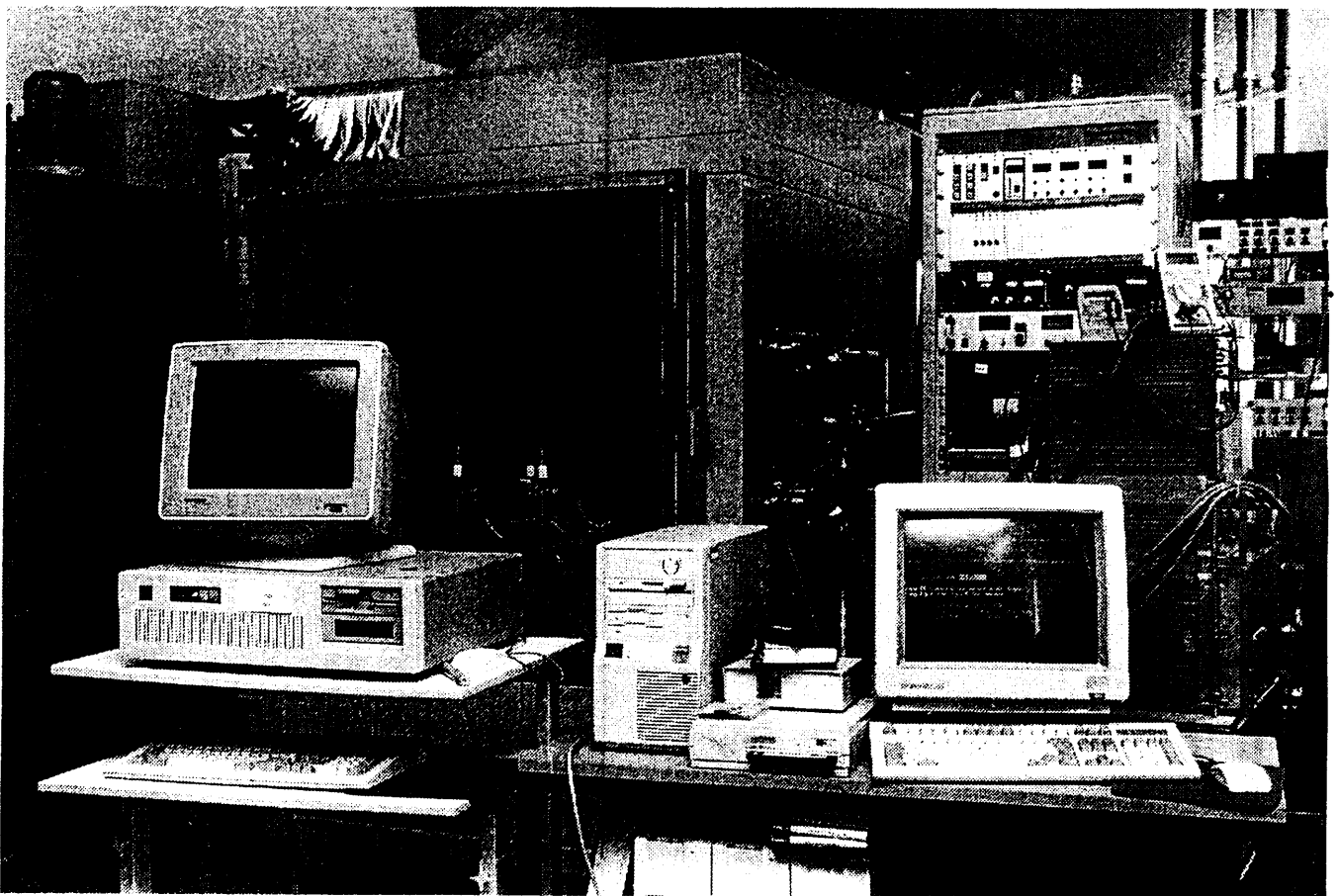

Figure 3: Environmental Simulation Chamber

3.3 Ozone Profile Simulator

To simulate vertical profiles of ozone dynamically in time as well as to achieve reproducible ozone concentrations a separate gas flowing system is installed to provide the 4 ozone sondes plus UV-photometer with regulated ozone concentrations at a gas flow rate of 12-15 l/min. The ozone profile simulator can simulate vertical profiles with ozone pressures varying between 0.1 and 35 mPa corresponding to altitudes from surface to 35 km. In addition, different types of ozone step functions or zero ozone can be applied in order to investigate the response time and background characteristics of the different ozone sondes.

3.4 Ozone Reference: Dual Beam UV-Photometer

The ozone reference is a fast response dual-beam UV-absorption photometer, developed by Proffitt et al. [1983] for the use on stratospheric balloons. The instrument had been flown several times during BOIC missions in 1983/1984 [Hilsenrath et al. (1986)]. It is an absolute reference device with a response time of about 1 second at a sampling volume flow rate of about 8 l/min. The precision of the photometer is about ± 0.025 mPa ozone. The overall accuracy of the ozone measurements made by the UV-Photometer as reference is better than $\pm 2\%$ for simulated altitudes up to 25 km while it slightly declines to $\pm 3.5\%$ at 30-35 km altitude.

The instrument is installed in a separate vacuum vessel which is connected to the simulation chamber such that the UV-photometer has the same pressure conditions as the test room.

3.5 Data Acquisition System

The entire simulation process is automated by computer control in order to have reproducible conditions with regard to the simulated profiles of pressure, temperature and ozone versus time as well as with regard to the synchronous recording and storage of the large variety of parameters measured during the simulation process.

The computer controlled ozone sounding simulation facility enables us to investigate simultaneously the performance of four different types of ozone sondes under quasi flight conditions. The technical specifications of the simulation facility are summarized in Table 2.

●	Test room volume = 500 liter (80x80x80 cm)
●	Computer controlled simulation according "real" atmospheric conditions:
a.)	Pressure: 10-1000 hPa
b.)	Temperature: 200-300 K
	● dynamic: Rate = ± 2 K/min
	● static: Fluctuations $\leq 0.1-0.2$ K
c.)	Ozone: 5-10000 ppbv (0.1-30 mPa)
●	Ozone Reference:
	Dual Beam UV-Photometer:
	* Response: 1 s
	* Precision: ± 0.025 mPa ,
	* Accuracy: $\pm 2\%$ (0-25 km), $\pm 3.5\%$ (30-35km)

Table 2: Specifications of World Calibration Facility for Ozone Sondes

4. Experimental Details

4.1 Introduction

The experiment was designed to evaluate the sensitivity, precision and accuracy of each sonde type at different pressure altitudes and ozone levels. Questions addressed by the experiment include:

- 1) How do pre-launch procedures influence in-flight sonde performances?
- 2) What is the time response of the different sondes?
- 3) How is the data analysis affected by such procedures as
 - Background signal correction
 - Total ozone column normalization.
 - Pump flow corrections at lower pressures

4.2 Simulated Profiles of Pressure, Temperature and Ozone

For a variety of simulated ascents 4 different types of ozone sondes were "flown" simultaneously. Two vertical profiles of pressure, temperature and ozone concentrations were selected (see Figure 4). The first was a typical mid-latitude profile taken from the US Standard Atmosphere (1976) for 40-50 °N with a tropopause height of 12 km. The second profile represented typical tropical (convective) conditions: high tropopause at 18 km, low tropopause temperature and extremely low ozone values in the middle and upper troposphere (Kley et al., 1996).

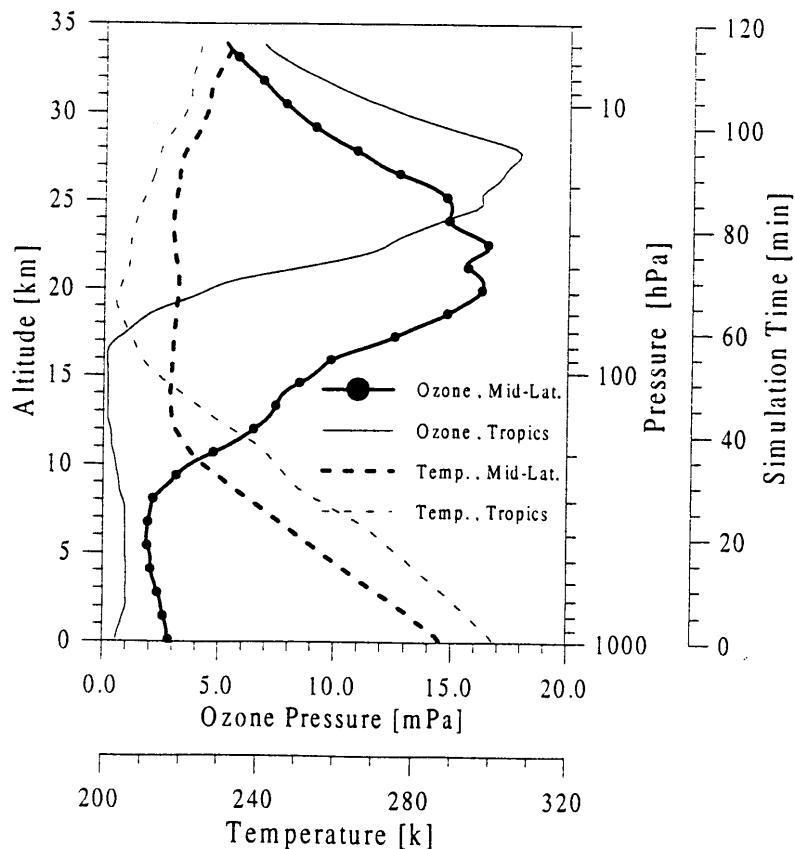

Figure 4: Vertical profiles of the simulation of ozone pressure and temperature at mid-latitude and tropical conditions

The pressure and temperature in the simulation chamber were regulated to follow an ascent velocity of 5 m/s up to an altitude corresponding to 35 km. The pressure inside the simulation chamber is measured with two capacitive manometers: 1 - 1000 hPa and 0.1-12.5 hPa , both with an accuracy better than ± 0.5 % of indicated readings. During the second part of the campaign a third capacitive manometer (0-100 hPa, accuracy better than ± 0.5 % of its reading) was used to monitor the pressure and to check the performance of the two other pressure transducers, particularly in the overlapping ranges. After the JOSIE-campaign the three manometers were recalibrated resulting in small pressure corrections compared to the pressure measured during the JOSIE-campaign. Due to spatial temperature variations of about 2-5°C to be expected inside the testroom of the chamber the temperature of the sample air intake of each sonde was individually measured with Pt100-resistors.

4.3 Data Acquisition

During the simulation runs the measured sensor current from each of the four ozone sondes tested in the simulation chamber were on-line integrated and recorded by the data acquisition system of the facility. Therefore interfacing electronics, specific for the different ozone sonde types, were used to convert the ozone sonde signal (electrical current) into a standard signal (0-5V) to be fed into the data acquisition system. Each participating team was individually responsible for their own adapting electronics. In addition, the actual temperature of the gas sampling pump of each sonde had been measured during the simulations with a thermistor (Type UUA41J1, Fenwal Electronics, accuracy $\pm 0.2^\circ\text{C}$ at 25°C) and also stored in the data acquisition system. For technical reasons an exception had to be made for the Japanese sonde whose sounding data were recorded by the acquisition system of the station. However, directly after each simulation run these data were also integrated in the data acquisition system of the facility. After each run the data of the 4 flown ozone sondes were processed following the normal procedures for post-flight data reduction. The data analysis routines had been formulated by the responsible participants and submitted to the intercomparison organizers prior to the JOSIE-campaign.

4.4 Ozone Sonde Data Processing

4.4.1 Basic Operating Formulas

Despite the different types of ozone sondes used in JOSIE, basically all sondes have in common that in principle each molecule of ozone forced through the sensing solution in the electrochemical cell generates an electrical current of approximately two electron in the external circuit. In other words, the electrical current generated in the electrochemical cell is directly related to the uptake rate of ozone in the sensing solution and is determined by the relation:

$$[\text{E-1}] \quad P_{\text{O}_3, \text{SONDE}} = C_{\text{SONDE}} * I_{\text{O}_3, \text{SONDE}}$$

By knowing the gas volume rate and its temperature the conversion coefficient C_{SONDE} is determined by:

$$[\text{E-2}] \quad C_{\text{SONDE}} = 0.04307 * \eta_{\text{SONDE}} * \frac{T_{\text{PUMP}}}{\Phi_{\text{V,PUMP}}}$$

$$\begin{aligned} P_{\text{O}_3, \text{SONDE}} &= \text{pressure of ozone, [mPa]} \\ T_{\text{PUMP}} &= \text{temperature of air sampling pump, [K]} \\ \Phi_{\text{V,PUMP}} &= \text{volumetric flow rate of air sampling pump, [ml/s]} \end{aligned}$$

$$I_{O_3,SONDE} = \text{electrical current due to sampled ozone, } [\mu A]$$

$$\eta_{SONDE} = \text{conversion efficiency of the ozone sensor}$$

The conversion efficiency η_{SONDE} is the overall result of the influences of several different parameters, such as absorption efficiency of O_3 into the sensing solution, stoichiometry of the conversion of O_3 into I_2 etc. In practice the conversion efficiency is approximately 100%.

The overall electrical current, $I_{M,SONDE}$, measured by the sonde may be a superposition of the ozone current, $I_{O_3,SONDE}$ and the background current, $I_{B,SONDE}$:

$$[E-3] \quad I_{O_3,SONDE} = I_{M,SONDE} - I_{B,SONDE}$$

$$I_{M,SONDE} = \text{Overall electrical current measured by ozone sensor due to ozone}$$

$$I_{O_3,SONDE} = \text{Electrical current measured by ozone sensor due to ozone}$$

$$I_{B,SONDE} = \text{Electrical current measured by ozone sensor due to background}$$

The equations E-1, E-2 and E-3 are the basic operating formulas for the data processing of the electrochemical ozone sensor.

All sonde data of each participating sounding laboratory were processed according to the standard operating procedures specific for the station, which were submitted by the different laboratories prior to the JOSIE-campaign in February/March 1996.

Despite the basic operating formulas given in equations E-1, E-2, and E-3, there are significant differences in data reduction and correction methods applied by the different sounding teams with regard to temperature of gas sampling, degrading pump efficiency at lower pressure, background correction and total ozone normalization. The specific reduction/correction methods used by the different participating teams are summarized in Table 3.

Participant [No.]	Sonde Type	Temperature Gas Sampling	Pump Flow Efficiency	Background Correction	Total Ozone Normalization
MOHp [1]	Brewer Mast [Original]	Constant 300 K	Empirical Table, Claude et al (1986)	None	Yes
CMDL [2]	ECC/ENSCI-1Z	Actual, Pump	Individual Calibration	Full	No
FZJ [3]	ECC/SPC-6A	Actual, Pump	Empirical Table, Komhyr (1986)	Oxygen dependent	No
IMD [4]	Brewer Mast Indian Hybrid	Empirical, Table IMD	Empirical Table, IMD-Laboratory	Full	Yes
ASP [5]	BM-Hybrid	Actual, Pump	Empirical Table, Komhyr (1986)	Full	Yes
AES [6]	ECC/SPC-5A ECC/ENSCI-1Z	Actual, Pump	Empirical Table, Komhyr (1986)	Oxygen dependent	Yes
CNRS [7]	ECC/SPC-5A	Actual, Pump	Empirical Table, Komhyr (1986)	Oxygen dependent	No
JMA [8]	RSII-KC79	Actual, Electrochem. Cell	Empirical Table, JMA-Laboratory	Oxygen dependent	Yes

Table 3: Specific reduction/correction methods used by the different participating laboratories

4.4.2 Temperature of Gas Sampling

To correct for changes of the air mass flow rate through the sensor due to temperature changes (see equation E-2) the actual (in-flight) temperature at the pump has to be known. Most of the participating laboratories have included the measured pump temperature in their post-flight data processing. Excepted are MOHp [1] (original Brewer-Mast sondes) and IMD [4] (Indian sondes). Based on the WMO-preparation procedures of Brewer-Mast sondes (Claude et al., 1986) MOHp [1] has applied a constant pump temperature of 300 K. The in-flight pump temperature of the Indian sonde IMD [4] was approximated using an empirical table of the pump temperature as function of ambient air pressure. The table had been obtained in the past from a series of soundings made over India under typical tropical ambient pressure and temperature conditions.

4.4.3 Pump Flow Efficiency Correction

The volumetric flow of the gas sampling pump of each sonde is individually measured before flight as part of the pre-flight preparation procedure. At ambient air pressures below 100 hPa the efficiency of the gas sampling pump degrades which is corrected for by applying an average pump efficiency correction table as function of ambient pressure specific for each sonde type. Most of the correction tables are based on averages obtained from rather old pump flow efficiency measurements made in the past. Excepted are the pump flow corrections applied by CMDL [2] which were based on individual pump flow calibrations made in their laboratory prior to the JOSIE-campaign. The different pump flow corrections used by the different laboratories are listed in Table 4

Pressure	MOHp[1] (Claude et al,1986)	CMDL[2] (*)	FZJ[3], ASP[5], AES[6], CNRS[7] (Komhyr, 1986)	IMD[4]	JMA[8]
1050	1	1	1	1	1
1000	1	1	1	1	1
500	1	1	1.002	1	1.002
300	1	1.003	1.005	1	1.005
200	1	1.008	1.007	1	1.007
100	1.01	1.018	1.01	1.01	1.02
50	1.035	1.035	1.015	1.037	1.04
30	1.065	1.053	1.024	1.061	1.07
20	1.092	1.071	1.033	1.092	1.11
10	1.17	1.12	1.054	1.16	1.25
7	1.24	1.16	1.068	1.21	1.40
5	1.3	1.21	1.087	1.27	1.66

Table 4: Pump efficiency correction as function of ambient pressure applied by the different laboratories. (*) The corrections listed in column of CMDL [2] are the average correction factors obtained over the individual pump flow calibrations (see text)

4.4.4 Background Correction

When no ozone is present the background signal of each ozone sonde was individually determined in the laboratory as part of the sonde preparation just prior to the simulation flight. Excepted are the Brewer-Mast sondes operated by MOHp [1], where this signal is assumed to be zero. The other laboratories have treated the background current as an offset of the measured signal (see also equation E-3). Four laboratories, FZJ [3], AES [6], CNRS [7] and JMA [8], have used the conventional method of background correction which assumes an oxygen dependency such that this offset gradually declines with decreasing pressure and is vanishing small in the upper troposphere and stratosphere. However, three laboratories, CMDL [2], IMD [4] and ASP [5], have applied a full subtraction of the background current throughout the entire profile

4.4.5 Total Ozone Normalization

The integrated column of ozone measured by the UV-photometer during the simulation of the ascent or the descent of a sounding experiment serves as a reference for the total ozone normalization. The total ozone normalization factor is defined as the ratio of the integrated columns of ozone obtained from the UV-photometer and the sonde respectively. For each individual sonde, the integrated column of ozone by the UV-photometer is determined using the air temperature measured at the air intake of the sonde. Parts of erratic or missing data in the vertical profile measured by the sonde and/or the UV-photometer were discarded for the ozone column integrations. No residuals of ozone above the maximum simulation altitude were calculated.

The total ozone normalization factor of each sounding has been determined to serve as a criterion to evaluate the quality of the ozone profile measured by the sonde. The laboratories MOHp [1], IMD [4], ASP [5], AES [6] and JMA [8] (See Table 3) adjusted each measured ozone profile by multiplying the measured sonde data with the corresponding total ozone normalization factor.

4.5 Formal Agreement and Data Protocol

Prior to the intercomparison campaign each participating laboratory has signed the JOSIE-formal agreement (See Appendix D) to abide by the strategy of the intercomparison campaign described in the JOSIE-Planning Report (Version 2.0, 1 February, 1996). Each participating team was individually responsible for its own profiling capabilities regarding the preparatory procedures prior and the data reduction procedures after the simulation runs in the chamber. An important aspect hereby was that each ozone sonde was prepared using procedures and equipment normally used by the field operator at the participant's sounding station and all participants used their own specific procedures for processing sonde data. Each principal investigator (PI) of the intercomparison campaign had also signed the JOSIE-data protocol (See Appendix E) describing the rights and duties of data usage by the participants of JOSIE.

4.6 Data Submission

The on-line recorded simulation data and the post-flight processed data were submitted „blind“ to the JOSIE-Data Base. During the campaign each participating team had only access to their own sonde data. An exception was made for the first simulation run of each campaign in which each participating team had also been provided with the ozone reference data of the UV-Photometer to review for proper functioning of the data acquisition and post-flight data processing of each sonde. The ozone reference data of the other simulation flights were handed over to the participating laboratories only at the end of each campaign.

After the JOSIE-campaign a three months period for data validation had been established to enable the participating laboratories to ensure that the post-flight data processing had been performed in a proper way. No irregularities have been identified. After their confirmation and signing the data protocol the JOSIE-data set were fixed and distributed among the participating laboratories (after signing the JOSIE-data protocol) via the JOSIE-ftp server located at Jülich. This final JOSIE-data set serves as base for the intercomparison of the performance of the different sondes „flown“ during the JOSIE-campaign.

4.7 Data Evaluation

The JOSIE-results were first presented at the XVIII Quadrennial Ozone Symposium L'Aquila, Italy, September 1996 (Smit et al., 1998). Further, the results were discussed and evaluated by all eight participating laboratories during a combined WMO/GAW-Workshop of JOSIE-Results/Standard Operation Procedures and SPARC/IOC- Evaluation of Data Quality of Ozone Sondes for Trend Assessment, held at the Meteorological Observatory Hohenpeissenberg (MOHp), Germany, 24-27 February 1997 and sponsored by WMO and hosted by the German Weather Service (DWD).

5. Results and Discussion

5.1 Introduction

The participants were split into two groups of four teams (See Table 1). Both groups attended the campaign for a two week period: 5 to 16 February (Campaign C-I) or 26 February to 8 March 1996 (Campaign C-II). During each campaign period (C-I and C-II) a total of six simulation experiments of vertical ozone soundings were performed: 4 simulation runs using a mid-latitude profile and 2 runs using a tropical profile (See Figure 4). Several times during a mid-latitude and a tropical simulation run ozone was temporarily set to zero level to investigate the response time and background characteristics of the different ozone sondes in the troposphere as well as in the stratosphere. The sixth and last run of each campaign part was a mid latitude profile modulated with a sinus wave to investigate the response characteristics of the different sondes.

As an independent and common time scale the actual day time recorded by the data acquisition system of the facility was used for processing the JOSIE-simulation data. Simultaneously to the recorded day time, a simulation time was supported which was set to zero at the start of the simulation. To compare the different sondes the profile data were made equidistant in time with a time step of 5 seconds.

Some minor parts of the simulated profiles of the simulation runs No. 1, 3 and 4 are missing, caused by accidental failure of the data acquisition system or UV-Photometer of the simulation facility. These missing data over intervals smaller than 1-4 min of simulation time, corresponding to 0.5-1.5 km altitude, were replaced by linear interpolated data over the erratic interval. Missing data of individual sondes, caused by instrumental problems of the sonde like freezing of the sensing solution or erratic data acquisition are flagged as non valid data in the JOSIE-data base. Specifications of the final JOSIE data set are presented in Appendix B in more detail.

During the first simulation run of each campaign some of the sondes showed in the upper part (above 25 km altitude) the problem of freezing of the sensing solution in the bubbler. This premature freezing of the solution is probably due to the fact that during JOSIE the

temperatures in the flightbox are about 5 to 10 °C lower than during field operation. This seems to be caused by missing solar radiation i.e. heating of the sonde box in the simulation chamber. Therefore precaution have been taken to prevent the freezing problem by adding either a small electrical resistance heater (1-2 W) or a small water bag as a heat capacity in the compartment of the Styrofoam flight box of the sonde.

The actual simulated altitude was calculated step by step as the cumulative sum of the height difference between two successive measured pressure levels plus corresponding air temperatures using the hydrostatic equation⁽⁷⁾.

5.2 Individual Simulation Runs

5.2.1 Introduction

The results of the twelve (2 x 6) individual simulation runs of each participating laboratory are presented in Appendix A of this report in the form of four plots. The first plot displays the complete individual vertical profiles of measured parameters like ozone (sonde & UV-Photometer), air temperature and pump temperature. The second plot shows the corresponding vertical profiles of the absolute and relative deviation of ozone measured by the sonde compared with the UV-Photometer as reference. The third and fourth plots present the tropospheric part of the first and second plot in more detail, respectively. Ozone pressure is presented in units of mPa (1mPa = 10 nbar)

The results of the individual profiles show that in general the sondes agree well with the ozone reference. Most sondes track the simulated ozone profiles quite well, which is particularly demonstrated by the mid-latitude simulation runs No. 6 and 12 with the modulated sinus wave (period length about 1-2 km).

Occasionally some of the Non-ECC sondes measured erratically (errors > ±50 %) in the troposphere with no apparent explanation like the Indian sonde of IMD [4] in simulation run No. 2 and 3 and the BM/ECC-hybrid of ASP in run No. 9.

5.2.2 Total Ozone Normalization as Screening Test

Even if the total ozone normalization factor is not used to correct the sonde profile it provides an excellent screening test for unreliable soundings using the criterion that the normalization factor may not deviate more than about 20 percent from one. However, the normalization factor is not a guarantee that the profile is correct. Table 5 shows the total ozone column normalization factor, which is the ratio of the integrated ozone profile measured by the UV-photometer and each sonde, for each sonde "flown" plus the mean factor and standard deviations for each participating laboratory. Using the normalization screening criterion as described above two sonde profiles, one of IMD (Indian sonde in simulation run No.2, normalization factor 1.25) and one of AES (ECC-sonde in simulation run No.10,

⁷ Hydrostatic equation is defined as $\Delta Z = \frac{R}{g} * \frac{T_{i+1} + T_i}{2} * \ln \left(\frac{P_i}{P_{i+1}} \right)$, whereby R= gas constant, g= gravity constant, T= temperature, P= pressure and indices i and i+1 are representing the two succeeding pressure levels

normalization factor 1.38), were excluded from the comparison due to non valid sonde data in a major part of the measured sounding profile.

Although all individual normalization factors range between 0.9 and 1.1, the variability (standard deviation) of the ECC-sonde types with values of ± 0.02 for three of the four ECC-stations are significantly smaller than the variability of the other types of sondes with values of $\pm(0.07-0.10)$. In the case of the CNRS [7], the standard deviation of 0.07 is mainly caused by the relative low normalization factor obtained from simulation run No.7 during campaign C-II (See Table 5). The results of this sounding showed to be unreliable because of an uncertain pump flow rate which showed to have changed from 170 ml/min to 230 ml/min during the simulation run⁽⁸⁾. The initial pump flow rate of 170 ml/min determined at the groundcheck prior to the simulation run turned out to be much lower than the pump flow rate of ECC-sondes which is typical 220 ± 20 ml/min and fairly constant. Therefore it was decided to exclude the results of this sounding from further comparison studies.

Further, it is to be noted that the normalization factors for the Non-ECC-type sondes are more close to unity than usually achieved during field operation at the sounding site (SPARC-IOCGAW Assessment of Trends in the Vertical Distribution of Ozone, 1998).

Sonde Type / Participant [No.]	Total Ozone Normalization Factor individual simulation runs						Mean	Standard Deviation
BM (original) / MOHP [1]	0.95	1.03	1.01	1.13	0.94	0.94	1.00	0.07
ECC (ENSCI-1Z) / CMDL [2]	0.93	0.92	0.90	0.88	0.93	0.92	0.91	0.02
ECC (SPC-6A) / FZJ [3]	1.01	0.98	0.97	0.98	1.00	1.01	1.00	0.02
Indian / IMD [4]	1.06	(*)	0.97	1.05	0.90	1.06	1.01	0.08
BM-Hybrid / ASP [5]	1.03	1.01	0.91	1.06	1.22	1.05	1.05	0.10
ECC (SPC-5A & ENSCI-1Z) / AES [6]	0.96	0.97	0.94	(*)	0.97	0.94	0.96	0.02
ECC (SPC5A) / CNRS [7]	0.90	1.09	1.03	1.09	1.07	1.07	1.04	0.07
KC79 / JMA [8]	0.86	0.96	0.84	0.89	1.09	0.85	0.91	0.10

Table 5: Summary of total ozone column normalization factors. Factors marked by (*) are non valid sonde data (see text). Total ozone normalization were only applied by the following stations: MOHP [1], IMD [4], ASP [5], AES [6] and JMA [8].

5.2.3 Special Case: Tropospheric Profiles in the Tropics

For the tropical profiles, Figure 5 show the sensor performance in the troposphere under very low ozone pressures (0.3-1 mPa) during the two tropical simulations of both campaigns (simulation runs No. 4, 5, 10 and 11). It is seen, that under these extreme conditions small structures (scale lengths ≥ 1 km) of the simulated vertical ozone profile are tracked rather well by all sondes flown. Most of the different types of sondes show for the tropical simulation runs a more or less systematic difference from the reference. Exceptions are the sondes

⁸ Inspection of the ECC-sonde operated by CNRS after simulation run nr. 7 showed traces of glue on the pump which are originated from tape used for mounting the thermal resistor to measure the actual pump temperature. The traces of glue might have affected a proper pump operation and caused a change of the pump flow rate during the simulation run.

operated by the IMD and ASP, which did not show constant deviations. However, the systematic deviations indicate that a more detailed analysis with a better procedure for determining and correcting the background signal of the sondes may improve the accuracy of the different sondes.

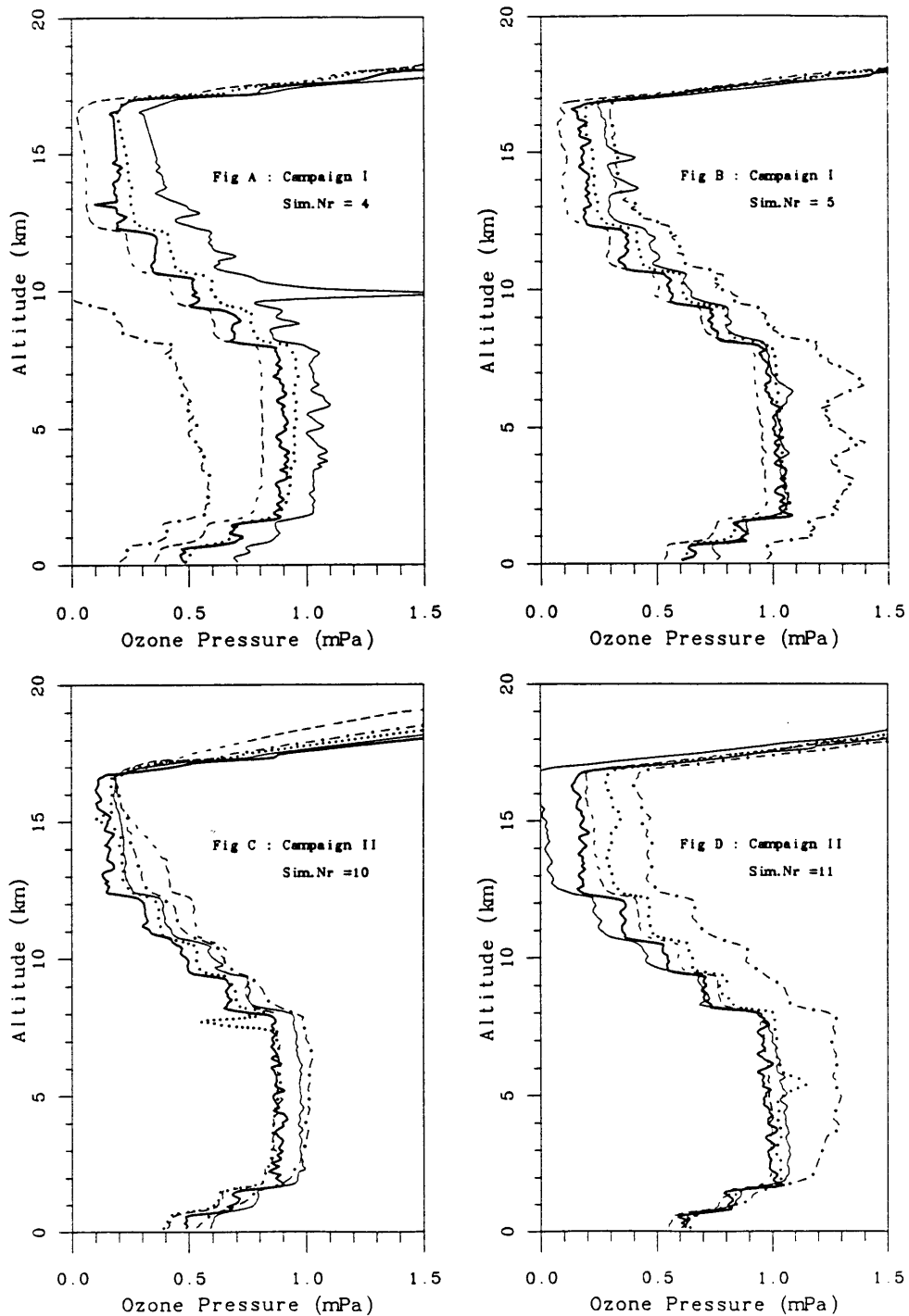

Figure 5: Vertical ozone profiles measured by the different sondes (thin lines) and UV-photometer (fat solid line) for the tropospheric parts of the tropical type of profiles. Campaign I (Fig. A, B): MOHp (solid), CMDL (dashed), FZJ (dotted), IMD (dahsed/dotted) Campaign II (Fig. C, D): ASP (solid), AES (dashed), CNRS (dotted), JMA (dahsed/dotted)

5.2.4 In-Flight Time Response

To investigate the response time and background characteristics of the different ozone sondes in the troposphere as well as in the stratosphere during a mid-latitude and a tropical simulation run ozone was temporarily set to zero level. The results are shown in the Figure 6 for the first part of the campaign (C-I) and Figure 7 for the second part of the campaign (C-II). From the individual response curves the response time⁹ and the observed offset at zero ozone of each sonde has been estimated and listed in Table 6. For the sake of clarity the presented sonde data were already corrected for background according to table 3.

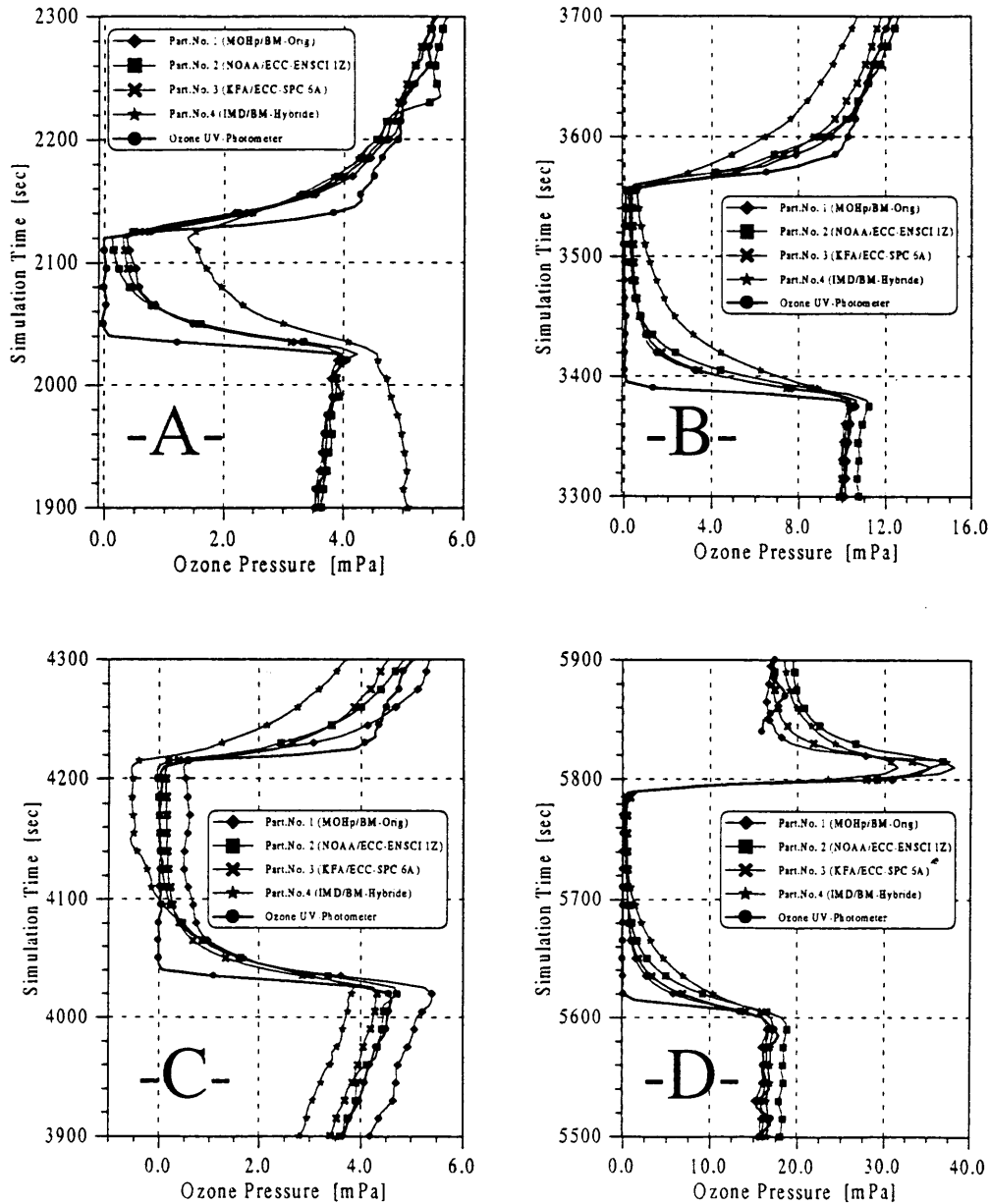

Figure 6: Time responses of the different ozonesondes when ozone was temporarily set to zero during the first part of the campaign (C-I)

⁹ The response time τ_{Res} on a downward response is defined as the time required that the signal $S(t)$ is decayed by a factor $1/e$ of its initial value $S(0)$, whereby $S(t) = S(0) * \text{Exp}[-t/\tau_{ECC}]$

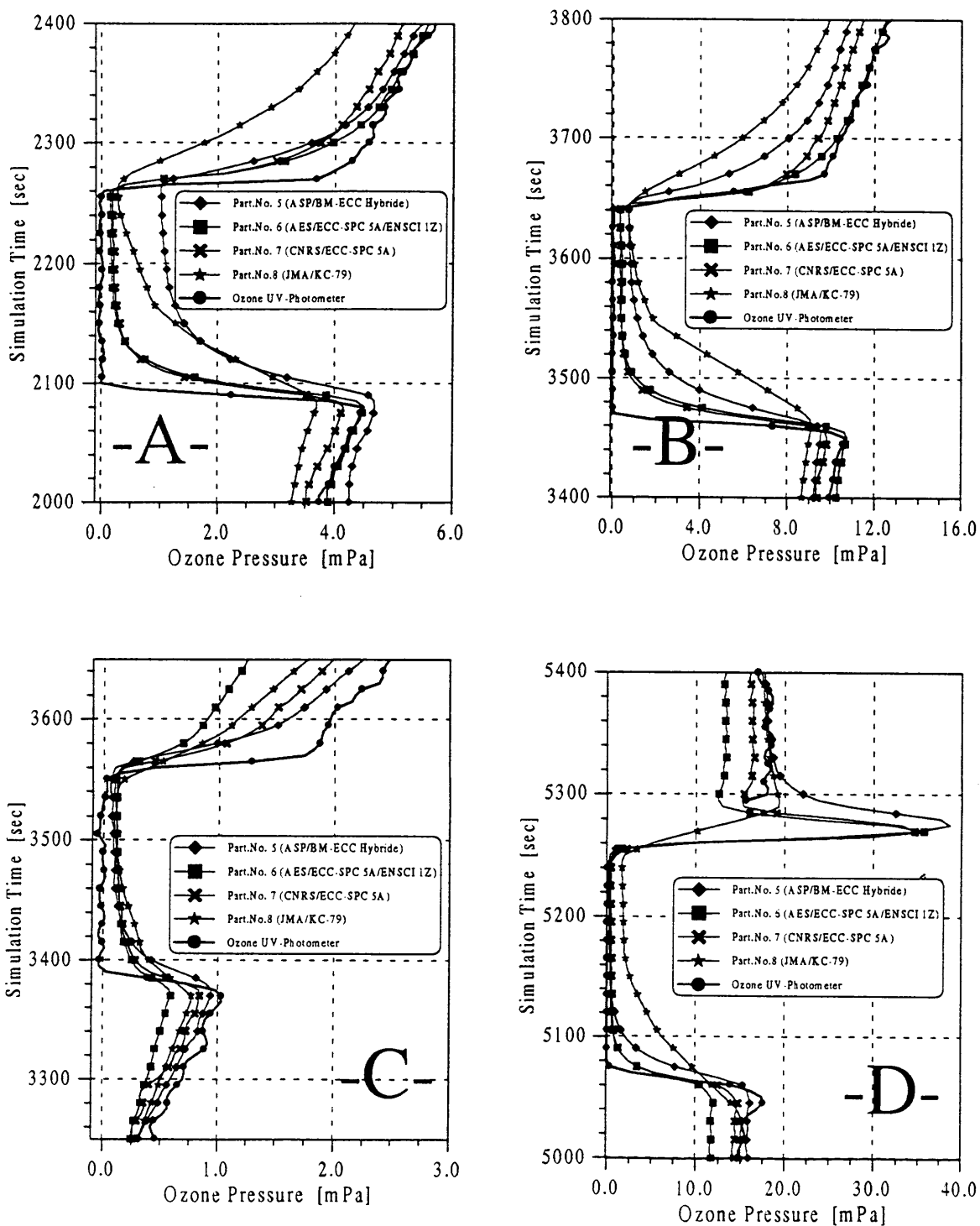

Figure 7: Time responses of the different ozonesondes when ozone was temporarily set to zero during the second part of the campaign (C-II)

In general, the time responses in upward as well as in downward direction are rather good for all tested sondes. The response time of the ECC-sonde types is within 25-30 seconds which corresponds at an ascent velocity of 5m/s to an altitude resolution of about 125-150 m. Similar results are obtained with the original Brewer-Mast sondes of MOHP [1] and the Brewer-Mast/ECC hybrid sondes of ASP [5]. The Indian sondes and Japanese KC79-sondes have slightly longer response times with values of about 40 seconds (200 m altitude resolution).

During periods of zero ozone none of the tested sondes returned to zero. The ECC-sonde types and the original Brewer-Mast sonde (MOHP [1]) showed the smallest offset signals with values of 0.1-0.4 mPa,. This in contrast with the Brewer-Mast/ECC hybrid sondes of ASP [5], the Indian sondes and the Japanese KC79 showed larger offset signals with higher variability ranging from -0.5 mPa to 1.0 mPa. At present the origin of these offset signals is not understood.

Sonde Type / Participant [No.]	Response Time [sec]				Offset [mPa]			
BM (original) / MOHP [1]	25	25	25	25	0.4	0.3	0.5	0.3
ECC (ENSCI-1Z) / CMDL [2]	25	25	25	25	0.25	0.3	0.05	0.25
ECC (SPC-6A) / FZJ [3]	25	25	25	25	0.35	0.35	0.15	0.4
Indian / IMD [4]	40	45	35	40	0.8	0.5	-0.5	-0.2
BM-Hybrid / ASP [5]	35	40	30	30	1.0	0.6	0.2	0.2
ECC (SPC-5A & ENSCI-1Z) / AES [6]	30	25	30	25	0.3	0.3	0.2	0.3
ECC (SPC-5A) / CNRS [7]	30	25	30	25	0.3	0.3	0.2	0.4
KC79 / JMA [8]	40	50	40	50	0.4	0.6	0.2	1.0

Table 6: Response time and offset of individual sondes obtained from in-flight response characteristics during simulation runs in which ozone was temporarily set to zero (see text). It is to be noted that the sonde data were already corrected for the background according Table 3.

5.3 Comparison Sondes with UV-Photometer

5.3.1 Introduction

Quantitative results of the sonde comparisons with the UV-photometer for both simulated profile types are shown for each participating sounding laboratory in the Figures 8-A to -H. and 9-A to -H. The comparison is presented as ozone pressure deviations (Figure 8) and as relative deviations (Figure 9) of the sonde readings from the UV-photometer, respectively.

The tropospheric parts of the tropical simulations are presented separately in Figure 5 (See Section 5.2.3).

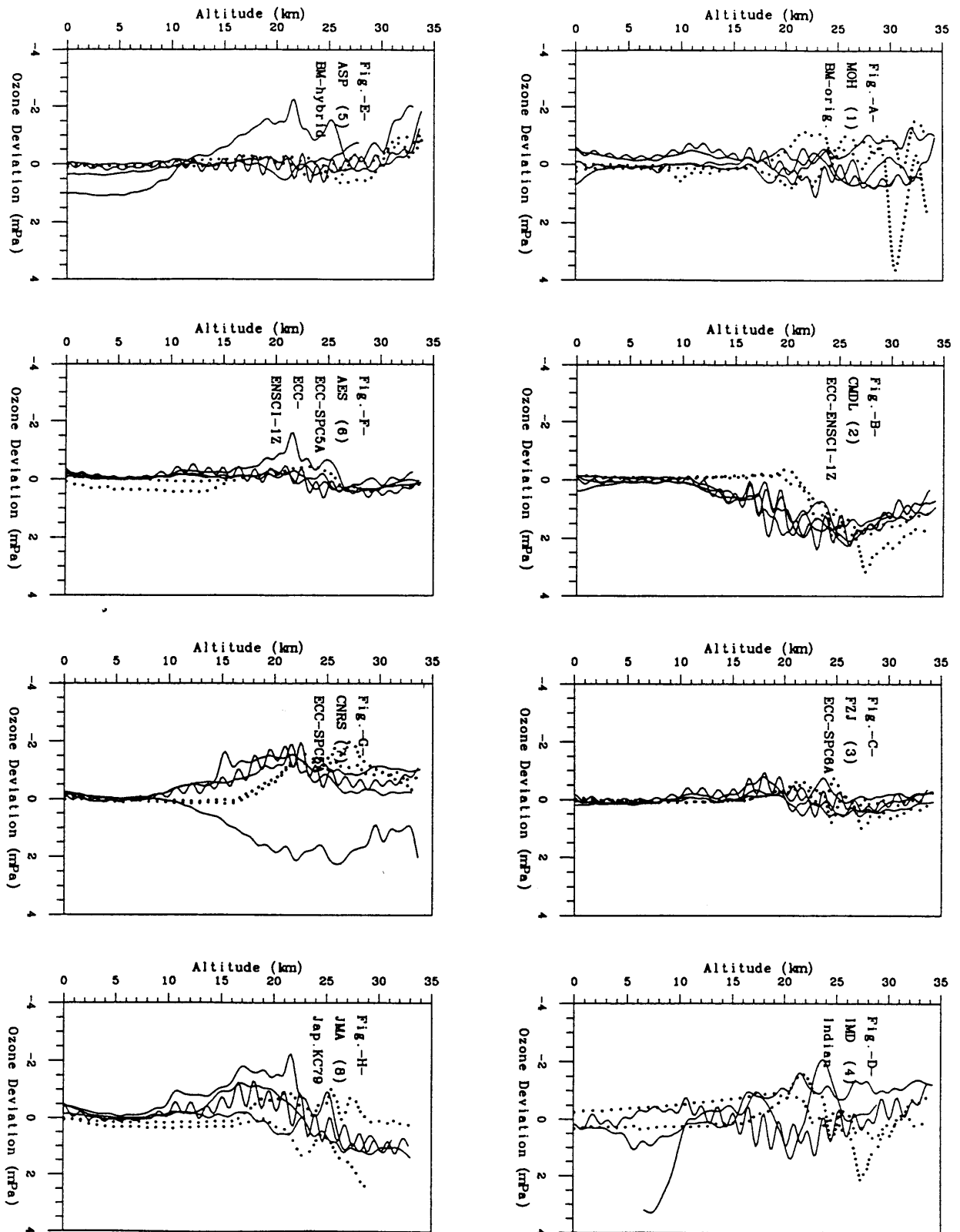

Figure 8: Ozone pressure deviations of the individual sonde readings from the UV-photometer for each participating laboratory obtained from the six simulation runs (4 mid latitudinal (solid lines) and 2 tropical profiles (dotted) as a function of altitude

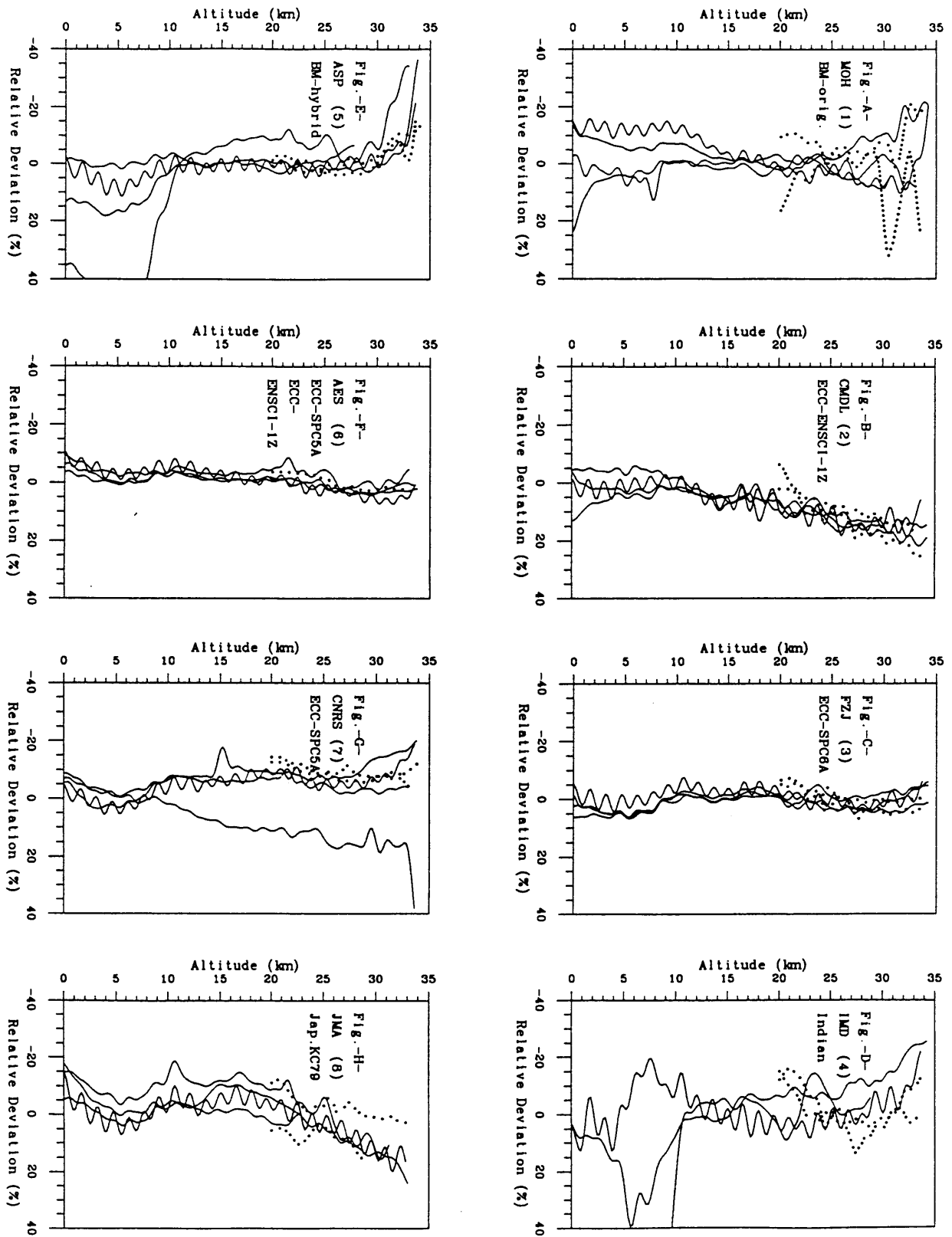

Figure 9: Relative deviations of the individual sonde readings from the UV-photometer for each participating laboratory obtained from the six simulation runs of the mid latitudinal (solid lines) and the tropical profiles (dotted) as a function of altitude. Tropospheric part of tropical profiles below 20km are excluded

For the tropospheric and stratospheric part of the mid latitude profiles as well as for the stratospheric part of the tropical profiles the sondes agree well with the UV-photometer. Relative deviations are typically within $\pm(5-15)$ % and occasionally $\pm(15-20)$ %. However, some systematic relative deviations are observed for some participants (CMDL [2], CNRS [7], JMA [8]) in the stratosphere with increasing magnitude in the middle stratosphere. From the ozone pressure deviations shown in Figure 8 it appears that, in the troposphere, the deviations of the sonde readings are rather small and first increase after encountering higher ozone levels in the stratosphere. This is clearly seen in Figures 8-B and 8-G by comparing the change of ozone pressure deviations of the sondes at the tropopause in the case of the tropical profiles (dotted lines, tropopause at 18 km) with mid-latitude profiles (solid lines, tropopause at 12 km). However, due to the much lower concentrations of ozone in the troposphere compared to the stratosphere the spread or variability of the relative deviations of the sonde readings in the troposphere (apart of some outlier profiles (IMD [4]: Sim.No.1 & 3, ASP [5]: Sim.No. 9), is larger than in the stratosphere.

5.3.2 Striking Features About Performance Characteristics of Different Sondes

Original Brewer-Mast Sondes by MOHP [1]:

The performance of the original Brewer-Mast sondes operated by MOHP [1] in the simulation chamber showed at low pressure a strikingly different performance compared with field operation at MOHP-sounding station. During JOSIE at altitudes above 28 km the BM/MOHP-sondes did not show a significant bias but agree within $\pm(5-10\%)$ with the UV-Photometer. This in contrast to field intercomparison of the sondes with lidar observations made at Hohenpeissenberg which have shown that Brewer Mast sondes tend to underestimate ozone at altitudes above 28 km. This feature is also confirmed by satellite data (e.g. SAGE 1 & 2, HALOE). This could be due to an inappropriate pump efficiency correction regularly applied to Brewer-Mast-sondes in the data processing procedure since the beginning of the sounding program in 1967. Corresponding laboratory investigations in the Hohenpeissenberg pressure chamber clearly revealed this shortcoming (Steinbrecht et al., 1998). However, during JOSIE it might be that the missing radiation heating of the Styrofoam box leads to more rapidly dropping temperatures inside the box than during field operation. Through the use of 300 K in the data processing algorithm instead of the actual temperature (See Section 4.4.2) a corresponding artificial ozone enhancement is generated. The premature freezing of the solution during the first simulation flight seems to be an indication of lower temperatures in the box.

ECC-Sonde Performance by CMDL [2] compared to FZJ [3] and AES [6]:

During JOSIE the ECC-sondes operated by CMDL [2] systematically overestimated ozone in the middle stratosphere above 25 km. Similarly to the JOSIE results CMDL-sondes show during field operation consistently 6-12% higher total ozone than simultaneous Dobson spectrophotometer total ozone measurements (Johnson et al., 1998). This is in sharp contrast to the results obtained with ECC-sondes operated by FZJ [3] and AES [6] which show better agreement with the UV-Photometer above 25 km altitude and also their total ozone normalization factors are more closely to one (See Table 5). The origin of the overestimated ozone measured by the ECC/CMDL-sondes at lower pressures is probably due to the use of a larger pump flow efficiency correction than the other ECC-sonde users (See Table 4) in combination with a change of sensitivity of the ozone sensor during flight operation. One source of uncertainty is, that by the time an ozone sonde reaches the middle stratosphere, it

has been operating for nearly 90 minutes. At this stage of the flight the uncertainties in the sensor cell characteristics are greater. First, a certain percentage of the sensing solution has evaporated at a rate dependent on the temperature of the cell and ambient pressure encountered during flight. For the ECC-sondes this means that, due to evaporation, the concentration of the sensing solution increases, which can have an enhancing effect on the sensitivity of the ECC-sensor and thus on the measured ozone (Barnes et al., 1985; Komhyr, 1969).

There are some experimental indications for ECC-sondes that, if the preparation and correction procedures prescribed by Komhyr (1986) are used, this sensitivity enhancement effect may be compensated by a too low conventional pump flow correction in the middle stratosphere. During JOSIE, this may be the case for the ECC-sondes operated by FZJ [3] and AES [6], which were using the same initial concentrations of sensing solutions and the same pump flow corrections (according Komhyr, 1986) and did not show any systematic deviations from the UV-photometer in the middle stratosphere. This is in contrast to the overestimation above 25 km altitude by the ECC-sondes operated by CMDL [2] which is probably caused by the larger pump flow correction (based on individual pump flow efficiency measurements in the laboratory) applied in combination with the sensitivity enhancement of the ECC-sensor due to evaporation. However, the process is not understood in detail up to now and more investigations are necessary to study this particularly in relation to the initial KI-concentration, the actual temperature of the sensing solution and the pump flow correction efficiency which together have an important influence on the sonde performance. Additional laboratory experiments and actual ozone sonde flight tests indicate that a 0.5% KI cathode solution, rather than 1% KI, can give better agreement with a calibrated ozone source, or when comparing with total column ozone from a Dobson spectrophotometer (Johnson et al., 1998). Recent laboratory studies of ECC-sondes have also indicated that the presence of the „P_H-buffering“ chemicals and their concentrations can have significant influences on the stoichiometry of the reaction of ozone with the potassium iodine in the sensing solution (Redox reaction [R1]) and thus can affect the ozone conversion efficiency of the cell (B. Johnson, private communications).

ECC-Sonde Performance by CNRS [7]:

In the troposphere the performance of the ECC-sondes operated by CNRS [7] is consistent with the performance of the ECC-sondes operated by CMDL [2], FZJ [3] and AES [6]. However, in the stratosphere the ECC operated by CNRS [7] show about 5-7 % lower ozone values than the ECC-readings obtained by FZJ [3] and AES [6]. Although FZJ [3], AES [6] and CNRS [7] using the same preparation procedures (Komhyr, 1986), CNRS-preparations deviate on one key point in as much as for cleaning purposes, the entire ECC-sonde (sensor+pump+motor) had been placed in a box with highly ozonized air (UV-Lamp). The ozonized air might have had a deteriorating effect on the pump motor or pump which could have lowered the pump flow rate during the simulation runs. After the JOSIE-campaign CNRS has abandoned this cleaning procedure from their standard operation procedures.

Brewer-Mast - ECC Hybrid by ASP [5]:

The JOSIE-results have shown that for this hybrid type of Brewer-Mast sensor with the non-reactive Teflon pump of the ECC-sonde more consistent results are obtained in the lower stratosphere than with the ordinary Brewer-Mast-pump. Nevertheless, the spread of the results of this hybrid BM/ECC-sonde is still larger than for an ECC-sonde, especially in the troposphere. This has also been observed during the Brewer-Mast / ECC field intercomparison

at Payerne in spring 1996 during SONDEX-96 (Hoegger and Schmidlin, private communication). Occasionally, in the troposphere, the sonde showed to be biased by more than 0.5 mPa, causing erratic readings of more than 20 %. A similar bias-effect had been occasionally seen for the Indian sonde (see below). The cause of the bias is not understood well.

Indian Sonde of the Brewer-Milford type:

In the lower stratosphere (below 25 km) the Indian sonde underestimates ozone slightly (0-5 %), while in the middle stratosphere this deficit is getting larger with altitude. In the troposphere the Indian sonde shows a large variability (up to ± 50 %) with a tendency to overestimate ozone. Striking feature is that occasionally in the troposphere the sonde is biased by more than 0.5-1 mPa, causing erratic readings up to $\pm 50\%$ in the troposphere, while the bias declines to almost zero in the stratosphere. First laboratory investigations at IMD (Srivastav, private communications) indicate that the bias, background current, first decline to zero after running the sonde for more than 20-30 minutes, which may explain the behavior of the sonde in the troposphere during JOSIE. However, the origin of this background current is not understood.

Japanese Sonde RSIK79 (JMA [8]):

In general JOSIE showed that for the KC79-sonde there was a tendency to underestimate ozone in the troposphere and overestimate ozone in the middle stratosphere (above 25 km altitude) compared with the UV-Photometer. JOSIE demonstrated for the KC79 the need for a re-evaluation of the pump-efficiency correction at lower pressure and to reconsider the proper correction of the background current. Also a memory effect of the background during flight had been identified. Investigations to improve the pump flow efficiency correction at low pressure are in progress and first results have shown better agreement with JOSIE-results.

5.3.3 Precision, Bias and Accuracy

To address precision and accuracy of the different sonde types the average plus/minus one standard deviation of the ozone pressure deviations and the relative deviations of the individual sonde readings from the UV-photometer for each participating laboratory obtained from the six simulation runs (4 mid latitudinal and 2 tropical profiles) as a function of altitude are presented in Figure 10 and 11, respectively. For the different sondes the precision is determined by the standard deviation of the average of the sonde deviations (= bias) with the UV-Photometer, while the accuracy is determined as the sum of sonde precision and the absolute value of its bias with the UV-Photometer.

A survey of the sonde bias and its precision are listed for each participating laboratory in altitude bins of 5 km in Table 7 (ozone pressure scale) and Table 8 (relative scale with regard to UV-Photometer)

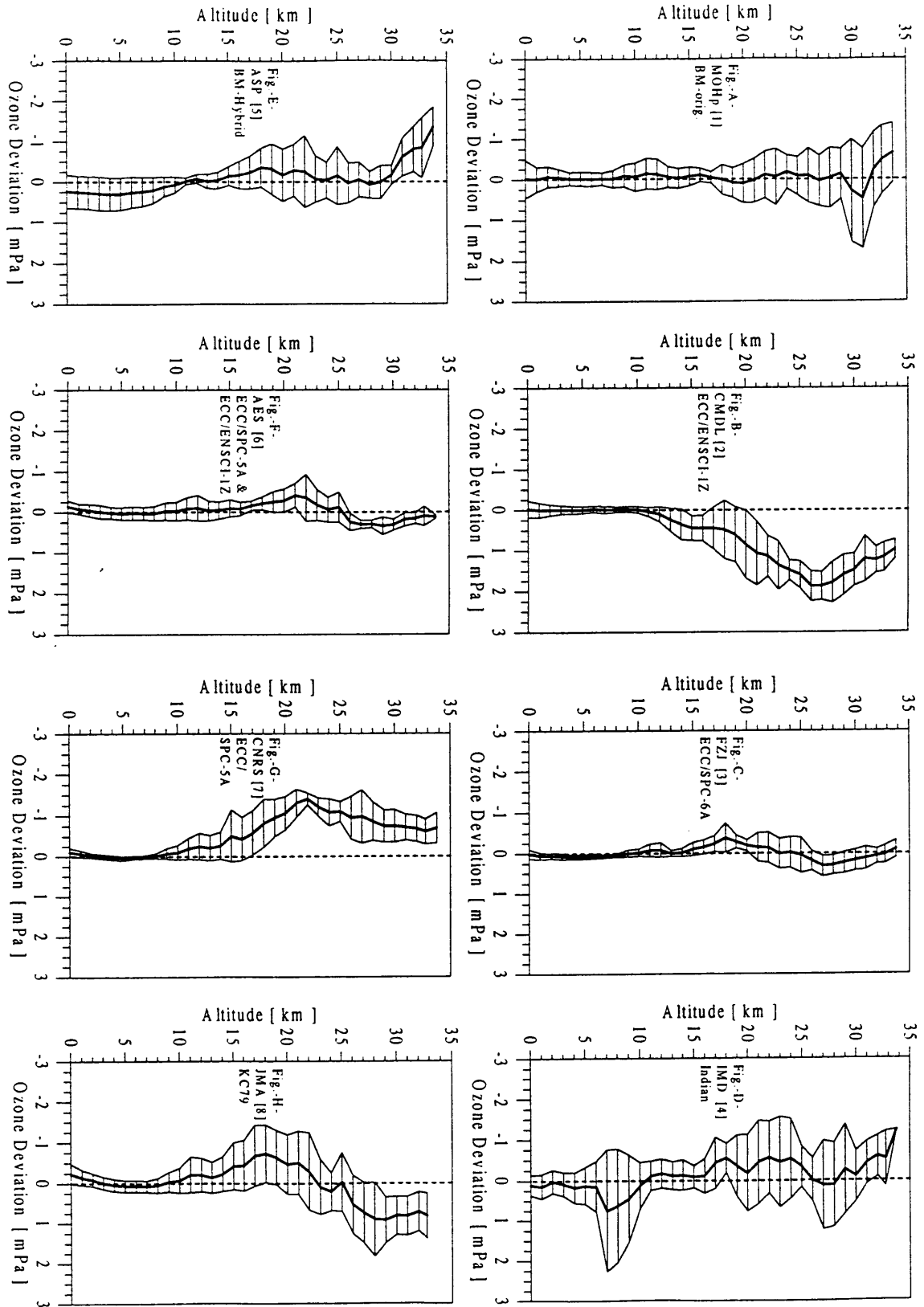

Figure 10: Mean (thick line) plus/minus one standard deviation (thin line) of the ozone pressure deviations of the individual sonde readings from the UV-photometer for each participating laboratory obtained from the six simulation runs (4 mid latitudinal and 2 tropical profiles) as a function of altitude

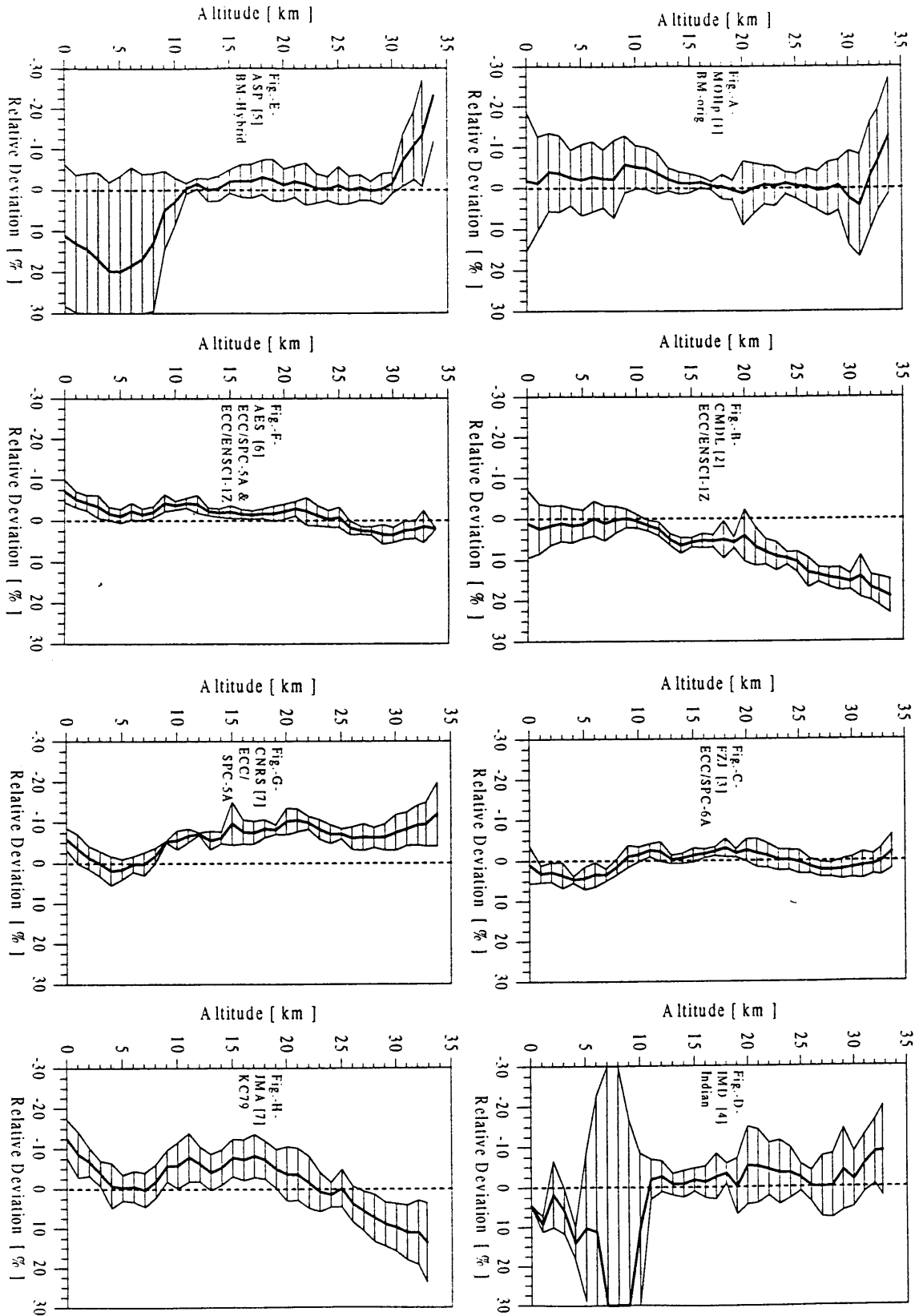

Figure 11: Mean (thick line) plus/minus one standard deviation (thin line) of the relative deviations of the individual sonde readings from the UV-photometer for each participating laboratory obtained from the six simulation runs as a function of altitude. Tropospheric parts of tropical profiles below 20km are excluded

Altitude Range [km]	MOHp [1] BM Orig [mPa].	CMDL [2] ECC ENSCI-IZ mPa].	FZJ [3] ECC SPC-6A [mPa].	IMD [4] Indian [mPa].	ASP [5] BM Hybrid [mPa].	AES [6] ECC SPC-5A & ENSCI-IZ [mPa].	CNRS [7] ECC SPC-5A [mPa].	JMA [8] KC79 [mPa].
30-35	-0.1 ± 1.0	1.3 ± 0.4	0.1 ± 0.2	0.1 ± 0.3	-0.7 ± 0.6	0.2 ± 0.2	-0.7 ± 0.3	0.8 ± 0.5
25-30	-0.1 ± 0.6	1.8 ± 0.4	0.2 ± 0.3	0.5 ± 0.1	-0.05 ± 0.5	0.2 ± 0.3	-0.9 ± 0.4	0.6 ± 0.8
20-25	-0.1 ± 0.5	1.2 ± 0.6	-0.1 ± 0.3	-0.1 ± 0.4	-0.2 ± 0.6	-0.3 ± 0.4	-1.2 ± 0.3	-0.2 ± 0.8
15-20	-0.05 ± 0.3	0.5 ± 0.5	-0.3 ± 0.2	-0.3 ± 0.5	-0.3 ± 0.4	-0.2 ± 0.2	-0.7 ± 0.5	-0.6 ± 0.7
10-15	-0.1 ± 0.3	0.1 ± 0.3	-0.05 ± 0.15	-0.4 ± 0.9	-0.0 ± 0.2	-0.05 ± 0.25	-0.2 ± 0.3	-0.2 ± 0.4
5-10	-0.05 ± 0.2	-0.01 ± 0.08	0.06 ± 0.07	-0.1 ± 0.9	0.2 ± 0.3	0.05 ± 0.15	-0.01 ± 0.08	0.1 ± 0.2
0-5	-0.05 ± 0.3	-0.1 ± 0.1	0.06 ± 0.08	-0.4 ± 0.6	0.3 ± 0.4	-0.05 ± 0.15	-0.04 ± 0.09	-0.1 ± 0.2

Table 7: Bias (systematic deviation) and precision of the different sondes operated by the participating laboratories splitted in altitude bins of 5 km. The accuracy is determined by the sum of the precision and the absolute value of the bias.

Altitude Range [km]	MOHp [1] BM Orig	CMDL [2] ECC ENSCI-IZ	FZJ [3] ECC SPC-6A	IMD [4] Indian	ASP [5] BM Hybrid	AES [6] ECC SPC-5A & ENSCI-IZ	CNRS [7] ECC SPC-5A	JMA [8] KC79
30-35	-2 ± 13 % (±15 %)	16 ± 4 % (±20%)	1 ± 3 % (±4 %)	-8 ± 9 % (±17 %)	-11 ± 11% (±22 %)	2 ± 3 % (±5 %)	-9 ± 5 % (±14 %)	11 ± 7 % (±18 %)
25-30	0 ± 5 % (±5 %)	13 ± 3 % (±16 %)	2 ± 2 % (±4 %)	-2 ± 7 % (±9 %)	-1 ± 4 % (±5 %)	2 ± 2 % (±4 %)	-7 ± 3 % (±10 %)	5 ± 6 % (±11 %)
20-25	0 ± 5 % (±5 %)	8 ± 4 % (±12 %)	-1 ± 3 % (±4 %)	-5 ± 8 % (±13 %)	-1 ± 4 % (±5 %)	-2 ± 3 % (±5 %)	-9 ± 3 % (±12 %)	-2 ± 6 % (±8 %)
15-20	-1 ± 3 % (±4 %)	5 ± 2 % (±7 %)	-2 ± 2 % (±4 %)	-2 ± 4 % (±6 %)	-2 ± 4 % (±6 %)	-2 ± 2% (±4 %)	-8 ± 3 % (±11 %)	-7 ± 5 % (±12 %)
10-15	-3 ± 5 % (±8 %)	3 ± 3 % (±6 %)	-2 ± 2 % (±4 %)	-1 ± 8 % (±9 %)	1 ± 4 % (±5 %)	-3 ± 2 % (±5 %)	-6 ± 2 % (±8 %)	-6 ± 5 % (±11 %)
5-10	-3 ± 8 % (±11 %)	1 ± 3 % (±4 %)	2 ± 3 % (±5 %)	30 ± 50 % (±80 %)	15 ± 18 % (±33 %)	-2 ± 2 % (±4 %)	-1 ± 3 % (±4 %)	-2 ± 4 % (±6 %)
0-5	-3 ± 10 % (±13 %)	2 ± 5 % (±7 %)	3 ± 3 % (±6 %)	8 ± 6 % (±14 %)	15 ± 17 % (±32 %)	-4 ± 3 % (±7 %)	-2 ± 4 % (±6 %)	-7 ± 6 % (±13 %)

Table 8: Relative bias (systematic deviation) and relative precision of the different sondes operated by the participating laboratories splitted in altitude bins of 5 km. The numbers between brackets is the accuracy determined by the sum of the precision and the absolute value of the bias. Tropospheric parts of the tropical simulation profiles are excluded.

From the values listed in table 7 and 8 follows that precision, bias and accuracy of the sondes of the different participating laboratories are strongly altitude dependent and vary in magnitude.

Precision:

For all sondes the relative precision is best in the lower stratosphere between tropopause and 25 km altitude, where ECC-sondes show a precision of about $\pm(2-3)$ %, while BM-Orig/MOHp, BM-Hybrid/ASP and KC79/JMA exhibit a precision of about $\pm 5\%$ and Indian/IMD of about $\pm(5-8)\%$. The Non-ECC type sondes show a lower precision in the troposphere and in the middle stratosphere above 25 km compared to the ECC sondes with a precision of about $\pm(3-4)\%$. In the troposphere BM-Orig/MOHp and KC79/JMA exhibit a precision of about $\pm(4-8)\%$, while Indian/IMD and BM-Hybrid/ASP show a considerably lower precision of about $\pm(5-20)\%$ with an extreme low precision in the middle troposphere. In the stratosphere above 25 km the Non-ECC type sondes exhibit a precision of about $\pm(5-13)\%$ for BM-Orig/MOHP, $\pm(7-9)\%$ for Indian/IMD, $\pm(4-11)\%$ for BM-Hybrid/ASP, and $\pm(6-7)\%$ for KC79/JMA.

Bias:

In the troposphere the ECC-sondes (CMDL, FZJ, AES, and CNRS) show a small bias varying between -3% and +3%, while BM-Orig./MOHp exhibits a similar small negative bias of -3% and KC79/JMA appears to have a negative bias between -2 and -7 %. The Indian and BM-Hybrid sondes operated by IMD and ASP respectively exhibit a positive bias larger than (10-20) % with a high level of uncertainty due to the large variability of the tropospheric signals measured by both sonde types (see also Section 5.3.2). Original BM-sondes operated by MOHp and ECC-sondes operated by FZJ and AES exhibit in the stratosphere up to 33-35 km altitude only a small bias varying between -2% and +2%. A similar small negative bias of -(1-2)% is seen for the BM-Hybrid/ASP-sonde in the lower stratosphere, while above 30 km altitude the negative bias is increasing rapidly with altitude. In the stratosphere the Indian/IMD-sonde show a varying negative bias of about -(2-8) % and the KC79/JMA-sonde exhibits a bias changing from -2% to 11% with altitude.

As discussed in the previous section 5.3.2 the positive bias of (8-16) % for ECC/CMDL-sondes as well as the negative bias of -(7-9) % for ECC/CNRS-sondes are not directly representative of the performance of the ECC-sonde in the stratosphere because it is obviously due to the use of certain operating procedures which differ from the guidelines given by Komhyr (1986).

Accuracy:

The sonde accuracy is derived from the sum of the sonde precision and the absolute value of the sonde bias with the UV-Photometer. The relative accuracy of the different sondes are also listed in table 8. In the troposphere the ECC-sondes show an accuracy better than $\pm(4-8)\%$, while the BM-Orig/MOHp and KC-79/JMA exhibit a similar accuracy of $\pm(8-13)\%$ and $\pm(6-12)\%$, respectively. The BM-Hybrid/ASP- and Indian/IMD-sondes show a much lower and non-stable accuracy of about $\pm(5-33)\%$ and $\pm(10-80)\%$, respectively. In the lower and middle stratosphere the ECC-sondes operated by FZJ and AES achieved the highest accuracy of $\pm(4-5)\%$. In the stratosphere below 30 km altitude BM-Orig/MOHp and BM-Hybrid/ASP achieved a similar accuracy of $\pm(4-5)\%$ and $\pm(5-6)\%$ respectively, but above 30 km both

sondes exhibit a strong with altitude decaying accuracy to values of $\pm(15-20)\%$. KC79/JMA-sondes show in the stratosphere below 30 km altitude an accuracy of about $\pm(8-12)\%$ and above 30 km also a strong decaying accuracy to values of $\pm 18\%$. The accuracy of the ECC/CMDL- and ECC/CNRS-sondes in the stratosphere is mainly determined by the relative large bias effects (see above) which have been identified in section 5.3.2.

5.4 Comparison JOSIE With Other Intercomparison Campaigns

5.4.1 Introduction

Since 1970 several dedicated short term campaigns to intercompare the different types of ozone sondes used in operational networks have been carried. The earlier campaigns, WMO-I and WMO-II at the Observatory of Hohenpeissenberg in 1970 and 1980 respectively (Attmanspacher and Dütsch, 1970 and 1981), and more recently in 1991 WMO-III at Vanscoy, Canada (Kerr et al., 1994) included only ozone sondes, so comparison of sonde results to a reference profile measured by a separate "standard" technique is not possible. This type of comparison allows only the determination of relative errors between the different sonde types as a function of altitude but not absolute systematic errors. However, all comparisons normalized the profiles to a common ground-based total ozone measurement to minimize systematic differences. Later intercomparisons such as BOIC (Hilsenrath et al., 1986), MAP/GLOBUS (Aimedieu et al., 1987), STOIC (Komhyr et al., 1995), OHP I & II (Beekmann et al., 1994,1995) used a reference profile measured by other techniques and results of these inter comparisons yield better estimates of absolute errors for the sonde measurement as a function of altitude.

5.4.2 Comparison in the Stratosphere

In the lower stratosphere (altitude:12 to 27 km) the JOSIE results agree rather well with the results obtained from other intercomparisons. The systematic differences between different sonde types have been less than 5% and the random variability from one sonde to another for all sonde types has also been less than 5%. This relatively low variability is also the result of the normalization of the profile to ground-based total ozone measurements because the normalization is mainly weighted to the ozone in the lower stratosphere which contains most of the column ozone.

Similar to JOSIE the intercomparison projects have also shown that the variability among ozone sondes generally increases again in the middle stratospheric region (27 km - to balloon burst altitude). For example, in the BOIC campaign 3 ECC ozone sondes (from different groups) and 1 Brewer-Mast sonde showed differences of about 10% as the balloon approached 30 km altitude. Results of the WMO III Vanscoy intercomparison included two additional types of sondes, the Indian and Japanese KC79 sondes. The variability in comparing all 4 types of sondes was even higher at about 10-15%, reaching 20% at 5 hPa (~35 km), whereby also radiosonde pressure variability had added to the uncertainty in the ozone profiles in the middle stratosphere. The magnitude of variations and errors in ozone sonde measurements in the middle stratosphere have been fairly consistent in showing larger variability in this region from past intercomparison projects and individual tests.

However, the results from the JOSIE campaign have shown very good precision and accuracy extending into the middle stratosphere up to 33-34 km altitude, especially for the ECC type sondes if operated according to the procedures described by Komhyr (1986). Similar findings are also obtained from comparison studies of ozone sonde time series with other profiling

technics such as lidar or microwave radiometer (SPARC-IOC-GAW Assessment of Trends in the Vertical Distribution of Ozone, 1998).

5.4.3 Comparison in the Troposphere

Like the JOSIE-campaign findings, the field intercomparisons have also shown that in the troposphere the sonde measurements are less precise (typically about $\pm 10\%$) than in the stratosphere, whereby Brewer-Mast type sondes showed to be less precise than the ECC sondes. JOSIE supports the results of field intercomparisons which have shown systematic differences between sonde types with typical values of 10 to 15 % and occasionally as much as 25% for some campaigns. Most campaigns (e.g. WMO I, WMO II, BOIC, OHP I, OHP II) have indicated that the ECC sonde can measure about 15% to 30% more than the Brewer-Mast in the troposphere which is in agreement with the JOSIE results. However, in contrast to the JOSIE-findings, the results of WMO III have suggested that the Brewer-Mast measures about 15% more than the ECC in the troposphere which is subject to considerable uncertainty with regard to ozone trends in the troposphere (SPARC-IOC-GAW Assessment of Trends in the Vertical Distribution of Ozone, 1998). Similar to the observations made during JOSIE one outcome of the different intercomparisons is that occasionally sondes, particularly Non-ECC sonde types, measure erratically (errors up to $\pm 50\%$) in the troposphere with no apparent explanation. The tropospheric error would not be apparent if these profile measurements were considered on their own.

It should be noted that the short term campaign results may not necessarily reflect the performance of ozone sondes under operational field conditions. Particularly for the non-ECC-type of sondes, like the older established BM-sounding stations (Hohenpeissenberg, Payerne and Uccle), the in-flight performance characteristics appear to be strongly coupled to the operational procedures followed at the different stations, but also to the location of the launch site (SPARC-IOC-GAW Assessment of Trends in the Vertical Distribution of Ozone, 1998).

6. Conclusions

The WMO-Jülich Ozone Sonde Intercomparison Experiment (JOSIE) was the first intercomparison campaign in which all operational types of ozone sondes were compared in a controlled environmental chamber capable of simulating real flight conditions. The controlled environment plus the fact that the ozone sonde measurements could be compared to a NIST-traceable UV-photometer as a reference allowed to address questions arising from the previous field intercomparisons.

The JOSIE results show that the sondes generally agree well with the ozone reference, particularly in the lower stratosphere between tropopause and about 25-30 km altitude. Most sondes track the simulated ozone profile quite well, even under extremely low ozone concentrations of the tropical troposphere. However, in the middle stratosphere as well as in troposphere the response of the different sonde types exhibit a larger variability. Occasionally, in the troposphere some of the BM-Hybrid and Indian sondes gave erratic readings of more than 50 % compared to the UV-photometer. The sondes recovered after entering the stratosphere.

JOSIE showed that the ECC-type sonde performance was best with regard to precision and accuracy if operated by the procedures described by Komhyr (1986). Under such conditions the precision in the troposphere and lower/middle stratosphere up to 35 km altitude is within

$\pm(3-4)\%$ and the accuracy about $\pm(4-5)\%$. JOSIE showed that the observed performance differences of the ECC-sondes were caused by the use of different operating procedures. JOSIE clearly demonstrated that even a small change of the operating procedures can have a significant impact on the overall performance of the sonde. Therefore close adherence to the standard operation procedures (SOP) of sondes is mandatory, and any changes in the SOP must be thoroughly tested and documented.

Most of the sondes showed above 25 -30 km variability that increased with altitude, particularly in the case of the non-ECC sonde types. This is mostly caused by a decrease of pump efficiency with altitude and a higher uncertainty at low pressures. At present, the pump flow rate is typically corrected at lower pressures by using a recommended average pump efficiency curve. However, more recent measurements indicate that at 5 hPa the pump efficiency is smaller than the recommended efficiency by about 10-12% for the ECC-Sonde (Johnson et al., 1998) and by even larger amounts for the Brewer Mast sonde (Steinbrecht et al., 1998; De Backer et al., 1998). It should also be noted that significant differences (more than 5-10 % at 5 hPa) are observed between the various experimental methods used to determine the pump flow efficiency at lower pressures. It is therefore recommended to compare and evaluate the various methods of pump flow calibrations.

The performance of the non-ECC type sondes showed in general higher variability and larger deviations from the UV-photometer measurements than the ECC. Also, the behavior of the different non-ECC-sonde types is quite different. The original BM-sonde operated by MOHp in the stratosphere up to 30 km altitude exhibited a precision of about $\pm(3-5)\%$ and an accuracy of about $\pm 5\%$, while in the troposphere the precision was somewhat lower with values of about $\pm 10\%$ and the accuracy was $\pm(10-13)\%$. The BM-Hybrid/ASP has a good performance in the lower stratosphere (precision $\approx \pm 4\%$ and accuracy $\approx \pm 5\%$) up to 30 km, but in the troposphere the sonde was exhibiting from a low precision ($\approx \pm 18\%$) and low accuracy ($\approx \pm 33\%$). The KC79/JMA tended to underestimate ozone in the troposphere (precision $\approx \pm 6\%$ and accuracy $\approx \pm 10\%$) and lower stratosphere (precision $\approx \pm 5\%$ and accuracy $\approx \pm 10\%$) and to overestimate ozone above 25 km altitude (precision $\approx \pm 7\%$ and accuracy $\approx \pm(11-18\%)$). The Indian/IMD sonde showed a precision of about $\pm(4-8)\%$ and an accuracy $\pm(6-13)\%$ in the lower stratosphere, with a tendency to lower performance above 30 km altitude. In the troposphere the IMD-sonde showed significant fluctuations and deviations from the UV-Photometer

In the free troposphere and lowest stratosphere ozone soundings provide the only time series of measurements to derive long term ozone trends. Due to the much lower concentrations of ozone in the troposphere compared to the stratosphere the performance of the sondes and their typical instrumental/operating factors determining precision and accuracy are rather different in both regions of the atmosphere. The impact of instrumental errors is larger when measuring the much lower values of tropospheric ozone. One instrumental error is the uncertainty in the sensor background current which varies in magnitude from one sonde to another as well as from one sonde type to another. Correction for the background current can have a significant impact on the measured tropospheric values in regions where the ozone concentration is low, i.e. near the tropopause. For ECC-sondes the conventional method of correction prescribed by Komhyr (1986) assumes the background current to be dependent on the oxygen partial pressure and decreases with altitude. Several laboratory studies (Thornton, et al., 1982, Smit et al., 1994) did not show any oxygen dependence on the background current. The accuracy of the ECC-sonde is significantly improved by using a constant background current correction throughout the entire vertical profile.

It also became apparent that all sonde types exhibit a „rest signal“ or memory effect after ozone was temporarily set to zero during some of simulation runs. The origin of this offset is not understood. Recent laboratory studies of ECC-sondes have indicated that the background signal of ECC-sondes can be positively correlated with past exposure to ozone (Johnson et al., 1998). As a consequence it was shown in a field study by Reid et al. (1996), that the best results with ECC-sondes are achieved when the background current is measured before the first exposure to ozone in the preparation procedure. No background correction is made to the BM-sonde records, but prior to flight the BM-sonde readings are electronically compensated for the background current. Nothing is known about any change of the background of the BM-sonde during flight. Any changes in the magnitude of the background current over the sonde record will directly affect the accuracy of the sensor, particularly in the free troposphere. It is of importance that more research be dedicated to the size and impact of the changes in the background current of different sonde types.

From recent laboratory investigations it appears that for ECC-sondes a change of the chemical composition of sensing solution will prevent the increase of sensitivity of the ECC-sensor due to evaporation during flight could be an improvement. However, this action should not be undertaken until the full implications of such a change have been evaluated and its impact on the interpretation of ozone trends is well understood. This is particularly the case for stations with long term records of ozone soundings. It is therefore recommended to investigate the characteristics of the sonde for different chemical compositions of the sensing solutions under different flight conditions and to evaluate the impact on long term sounding records after an eventual change of the sensing solution.

The JOSIE results in the lower stratosphere are in good agreement with comparisons of ozone sondes with other ozone profiling techniques and show consistent results with agreement of about $\pm(3-5)$ % at altitudes between the tropopause and 28 km. The precision of the different sonde types is better than ± 5 %. Above 28 km the results are not consistent due to instrumental uncertainties (e.g. pump corrections and sensing solution changes).

A dearth of sonde validation studies exist for the troposphere and because of the small number of comparisons, only estimates about the reliability of the sonde data records below the tropopause can be made. JOSIE shows that ECC-sondes provide much more consistent results than the other types of sondes. The precision of the ECC-sonde is $\pm (5-10)\%$ and shows a small positive bias of about 3 %. Brewer Mast and KC79-sondes are less precise ($\pm(10-20)\%$), but there are no indications of any bias larger than ± 5 %. Key issues of uncertainty in the troposphere are the background correction and the use of the total ozone normalization factor.

The main reasons for observed differences between the different sounding laboratories using the same type of ozone sonde are believed to be due to differences in the preparation and correction procedures applied at the different launch sites. Although much progress has been made to improve the quality and homogeneity of the ozone sonde data since the last WMO Scientific Assessment of Stratospheric Ozone in 1994, there is still a need to investigate and intercompare the instrumental performance of the different sonde types as well as a need to revise and agree on procedures for preparation and data processing (SPARC-IOC-GAW Assessment of Trends in the Vertical Distribution of Ozone, 1998).

With regard to the use of sonde data to assess tropospheric and stratospheric ozone, the precision of the instrument plays the key role while any systematic bias is of minor importance. For a sounding station in an operational network it is of great importance to assure constant and regular handling of the sonde and the data. inhomogeneities and

discontinuities due to changes in instrument or preparation procedures can have large influences on ozone trends derived from the sounding record (SPARC-IOC-GAW Assessment of Trends in the Vertical Distribution of Ozone, 1998). JOSIE clearly demonstrates that there is a need for the harmonization of operating procedures for pre-launch preparation and post-flight data processing.

Furthermore, there is a need for research to get a more fundamental understanding of the influences of instrumental factors such as background signal, sensing solution, pump efficiency in order to quantify the resulting uncertainties. In addition, JOSIE showed that all sonde types can yield, at least under controlled simulation conditions, total ozone normalization factors close to unity. Therefore, it is recommended that the use of the total ozone normalization as a correction factor should be re-evaluated not only for the tropospheric but also for the stratospheric part of the ozone profile.

JOSIE brought valuable information about the performance of the different ozone sonde types and the influence of the operating, preparation, and data correction procedures applied by the participating laboratories. JOSIE showed also that there is a need to calibrate or test ozone sondes on a routine basis. Ozone sondes have gone through some modifications since they were first manufactured, which adds uncertainty to trend analysis. Routine testing of the ozone sondes directly from manufacturers on a regular basis, following a standard operating procedure, will help to ensure more confidence in observed trends in the past and in the future. A pre-requisite thereby is the standardization of the preparation procedures and data correcting methods in the near future, but also a better and more detailed documentation of the procedures and methods applied in the past at the different long term ozone sounding stations.

Acknowledgment

We want to thank Dr. Volker Mohnen and Dr. John Miller for their personal contribution to JOSIE and arranging financial support for some of the participants. Also many thanks to Mrs. Judith Wimmer for the preparation of most of the figures. JOSIE was sponsored by WMO/GAW, QA/SAC-Germany and Forschungszentrum Jülich.

References

- Aimedieu, P., W.A. Matthews, W. Attmannspacher, R. Hartmannsgruber, J. Cisneros, W. Komhyr, D.E. Robbins, Comparison of in-situ stratospheric ozone measurements obtained during the MAP/Globus 1983 campaign, *Planet. Space Sci.*, 35, 563-585, 1987.
- Attmannspacher, W. and H. Dütsch, International Ozone Sonde Intercomparison at the Observatory of Hohenpeissenberg, *Berichte des Deutschen Wetterdienstes*, 120, 1970.
- Attmannspacher, W. and H. Dütsch, 2nd International Ozone Sonde Intercomparison at the Observatory of Hohenpeissenberg, *Berichte des Deutschen Wetterdienstes*, 157, 1981.
- Barnes, R.A., A.R. Bandy,, and A.L. Torres, Electrochemical concentration cell ozone sonde accuracy and precision, *J. Geophys. Res.*, 90, 7881-7887, 1985.
- Beekmann, M., G. Ancellet, G. Megie, H.G.J. Smit, and D. Kley, Intercomparison campaign for vertical ozone profiles including electrochemical sondes of ECC and Brewer-Mast type and a ground based UV-differential absorption lidar, *J. Atmos. Chem.*, 19, 259-288, 1994.
- Beekmann, M., G. Ancellet, D. Martin, C. Abonnel, G. Duverneuil, F. Eidelimen, P. Bessemoulin, N. Fritz and E. Gizard, Intercomparison of tropospheric ozone profiles obtained by electrochemical sondes, a ground based lidar and airborne UV-photometer, *Atmos. Env.*, 29, 1027-1042, 1995.
- Brewer, A. and J. Milford, The Oxford Kew ozone sonde, *Proc. Roy. Soc.London, Ser. A*, 256, 470, 1960.
- Claude, H., R. Hartmannsgruber, and U. Köhler, Measurement of atmospheric ozone profiles using the Brewer/Mast sonde, WMO Global Ozone Research and Monitoring Project Report No. 17, 1986.
- De Backer H., D. De Muer, E. Schoubs and M. Allaart, A new pump correction profile for Brewer-Mast ozone sondes, *Proceedings of the XVIII Quadrennial Ozone Symposium*, Eds. R. Bojkov , and G. Visconti, L'Aquila, Italy, September 1996, 891-894, 1998.
- Global Atmosphere Watch Guide, GAW-Report No. 86, WMO/TD-No. 553, World Meteorological Organization, Geneva, 1993.
- Hilsenrath, E., W. Attmannspacher, A. Bass, W. Evans, R. Hagemeyer, R.A. Barnes, W.Komhyr, K. Mauersberger, J. Mentall, M. Profitt, D. Robbins, S. Taylor, A. Torres and E. Weinstock, Results from the Balloon Ozone Intercomparison Campaign (BOIC), *J. Geophys.Res.* 91, 13137-13152, 1986.
- Johnson, B. J., S. J. Oltmans, D. J. Hofmann, J. A. Lathrop, Evaluation of ECC ozone sonde performance from recent field and laboratory intercomparisons, *Proceedings of the XVIII Quadrennial Ozone Symposium*, Eds. R. Bojkov , and G. Visconti, L'Aquila, Italy, September 1996, 927-930, 1998.
- Kerr, J.B., H.Fast, C.T. McElroy, S.J. Oltmans, J.A. Lathrop, E. Kyro, A. Paukkunen, H. Claude, U. Köhler, C.R. Sreedharan, T. Takao, and Y.,Tsukagoshi, The 1991 WMO International Ozone Sonde Intercomparison at Vanscoy, Canada, *Atm. Ocean*, 32, 685-716, 1994.
- Kley, D., P.J. Crutzen, H.G.J. Smit, H. Vömel, S.J. Oltmans, H. Grassl, and V. Ramanathan, Observations of near-zero ozone levels over the convective Pacific: Effects on air chemistry, *Science*, 274, 230-233, 1996.

- Kobayashi, J., and Y. Toyama, On various methods of measuring the vertical distribution of atmospheric ozone (III) - Carbon iodine type chemical ozone sonde-. *Pap. Met. Geophys.*, 17, 113-126, 1966
- Komhyr, W.D., A carbon-iodine ozone sensor for atmospheric soundings, *Proc. Ozone Symposium Albuquerque 1964*, WMO, 26- , 1965.
- Komhyr, W.D., and T.B. Harris, Note on flow rate measurements on Mast-Brewer ozone sensor pumps, *Monthly Weather. Rev.*, 93, 267-268, 1965.
- Komhyr, W.D., Nonreactive gas sampling pump, *Rev. Sci. Inst.*, 38, 981-983, 1967.
- Komhyr, W.D., Electrochemical concentration cells for gas analysis, *Ann.Geoph.*, 25, 203-210, 1969.
- Komhyr, W.D., Development of an ECC-ozone sonde, NOAA Techn. Rep. ERL 200-APCL 18ARL-149, 1971.
- Komhyr, W.D., Operations handbook - Ozone measurements to 40 km altitude with model 4A-ECC-ozone sondes, NOAA Techn. Memorandum ERL-ARL-149, 1986.
- Komhyr, W.D., R.A. Barnes, G.B. Brothers, J.A. Lathrop, and D.P. Oppermann, ECC ozone sonde performance evaluation during STOIC 1989, *J. Geophys. Res.*, 100, 9231-9244, 1995.
- Müller, J.I., Flight preparation instructions for the model 730-8 ozone sonde, Mast Development Company, 1976.
- Proffitt, M.H., and R.J. McLaughlin, Fast response dual-beam UV-absorption photometer suitable for use on stratospheric balloons, *Rev. Sci. Instrum.*, 54, 1719-1728, 1983.
- Reid S.J., G. Vaughan, A.R. Marsh, and H.G.J. Smit, Intercomparison of ozone measurements by ECC sondes and BENDIX chemiluminescent analyser, *J. Atm. Chem.*, 25, 215-226, 1996.
- Smit, H.G.J., W. Sträter, D. Kley, and M.H. Proffitt, The evaluation of ECC-ozone sondes under quasi flight conditions in the environmental simulation chamber at Jülich, in P.M. Borell et al. (eds.), *Proceedings of Eurotrac symposium 1994*, 349-353, SPB Academic Publishing bv, The Hague, The Netherlands, 1994.
- Smit, H.G.J., W. Sträter, M. Helten, and D. Kley, The Environmental Simulation Chamber at Forschungszentrum Jülich: A Calibration Facility for Airborne Ozone and Humidity Sensors, *Berichte des Forschungszentrums Jülich*, In Press, 1998.
- Smit H.G.J., W. Sträter, M. Helten, D. Kley, D. Ciupa, H.J. Claude, U. Köhler, B. Hoegger, G. Levrat, B. Johnson, S.J. Oltmans, J.B. Kerr, D.W. Tarasick, J. Davies, M. Shitamichi, S.K. Srivastav, C. Vialle, and G. Velghe, JOSIE: The 1996 WMO International intercomparison of ozone sondes under quasi flight conditions in the environmental simulation chamber at Jülich, *Proceedings of the XVIII Quadrennial Ozone Symposium*, Eds. R. Bojkov , and G. Visconti, L'Aquila, Italy, September 1996, 971-974, 1998.
- SPARC-IOC-GAW Assessment of Trends in the Vertical Distribution of Ozone, SPARC report No.1, WMO Global Ozone Research and Monitoring Project Report No. 43, 1998.
- Steinbrecht W., R. Schwartz, and H. Claude, New pump correction for the Brewer Mast ozone sonde: Determination from experiment and instrument intercomparisons, *J. Atmos. & Ocean. Technol.*, 15, 144-156, 1998.

Thornton, D.C., and N. Niazy, Sources of background current in the ECC-ozone sonde: Implication for total ozone measurements, J. Geophys. Res., 87, 8943-8950, 1982.

U.S. Standard Atmosphere, NOAA, NASA, USAF, U.S. Government Printing Office, Washington, D.C., 1976.

WMO (=World Meteorological Organization) , Scientific Assessment of Ozone Depletion: 1994, Global Ozone Research and Monitoring Project - Report No. 37, World Meteorological Organization, Geneva , 1995.

WMO report No. 104, Report of the fourth WMO meeting of experts on the quality assurance/science activity centers (QA/SACs) of the global atmosphere watch. Jointly held with the first meeting of the coordinating committees of IGAC-GLONET and IGAC-ACE at Garmisch-Partenkirchen, Germany, 13-17 March 1995, WMO TD.No. 689

Appendix A

Results

of

Individual Simulation Runs

of

Each Participating Laboratory

Sim.Exp.Nr. = 1 Date = 07 February 1996 Type Profile = Mid Latitude
 Part.Lab.(1) = MOHp Sonde = BM/Original

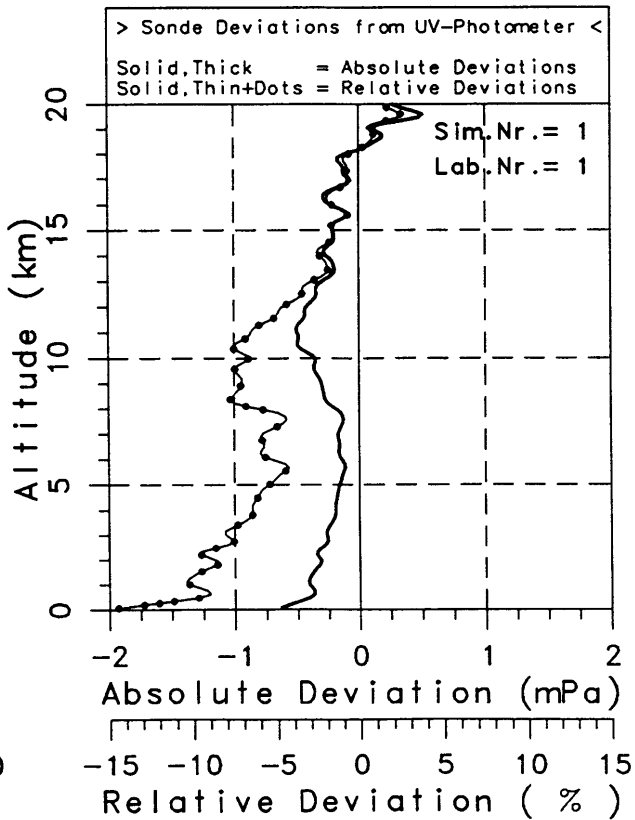
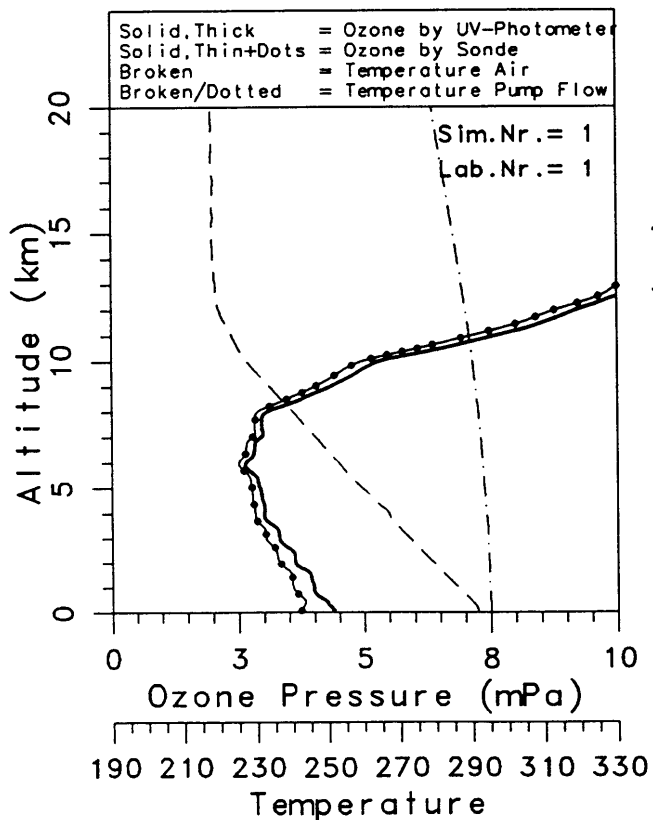
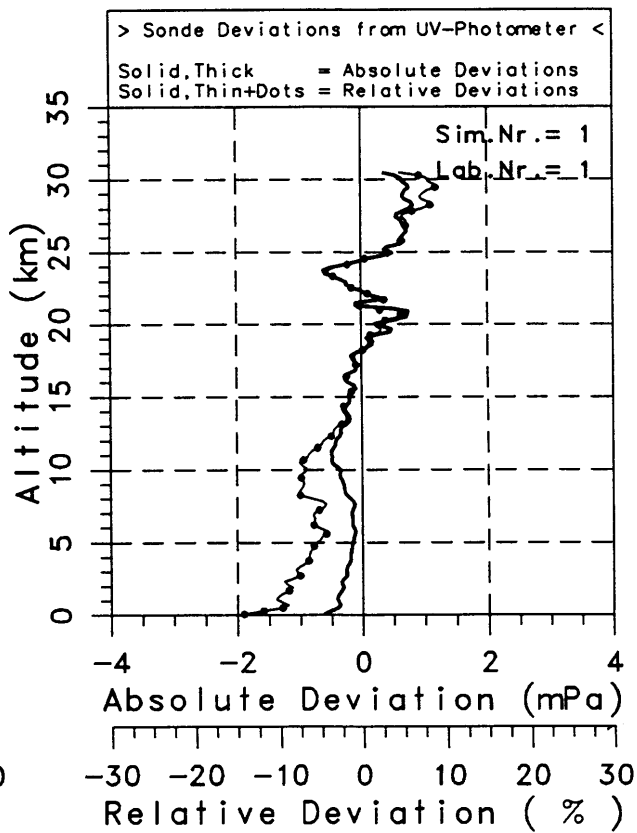
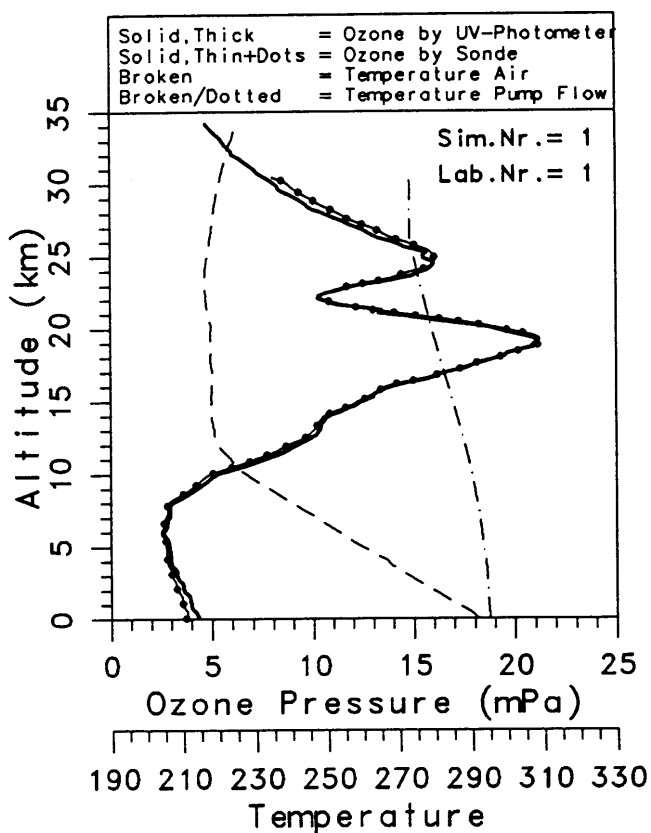

Sim.Exp.Nr. = 1 Date = 07 February 1996 Type Profile = Mid Latitude
 Part.Lab.(2) = NOAA/CMDL Sonde = ECC/ENSCI-1Z

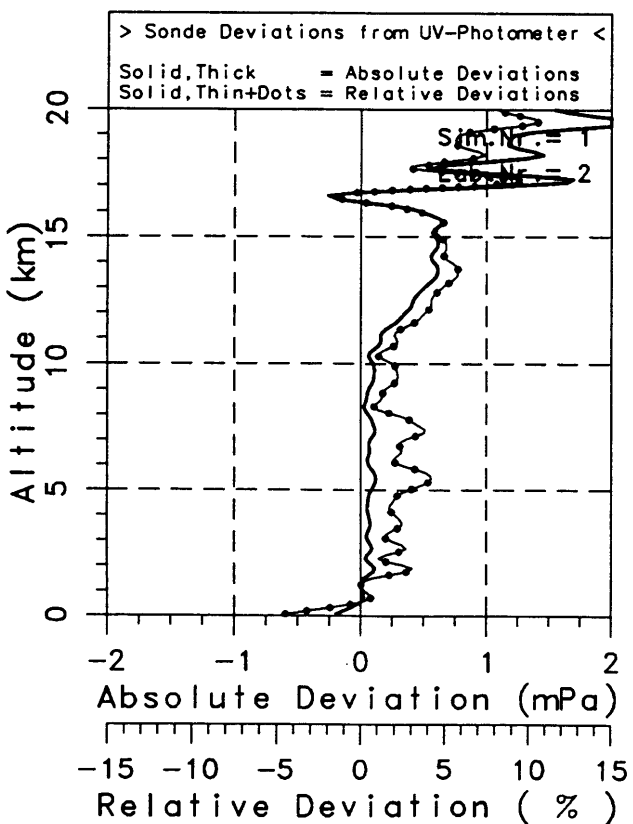
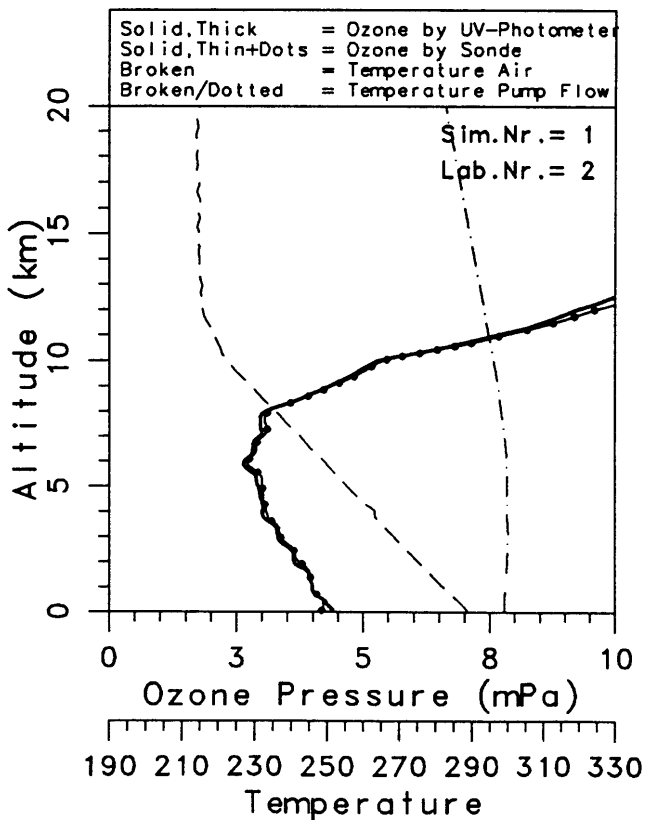
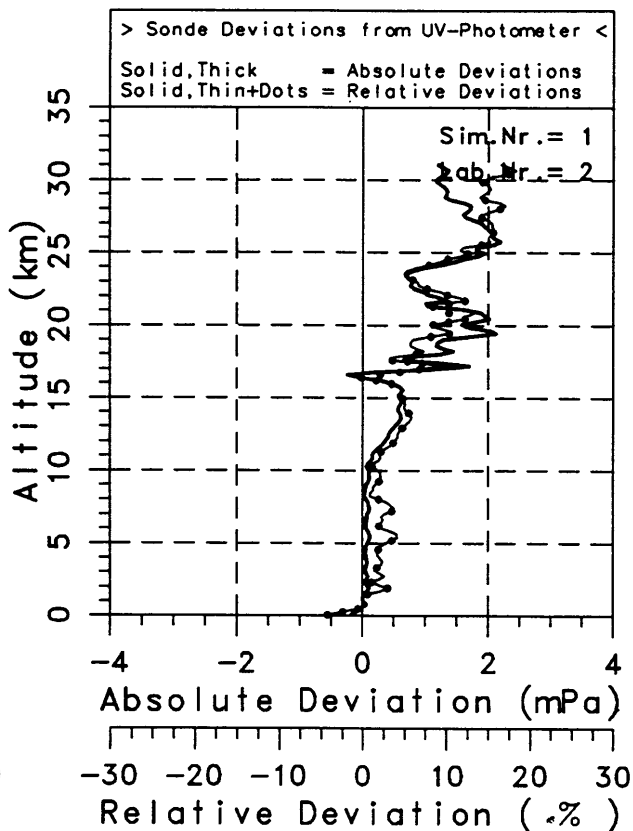
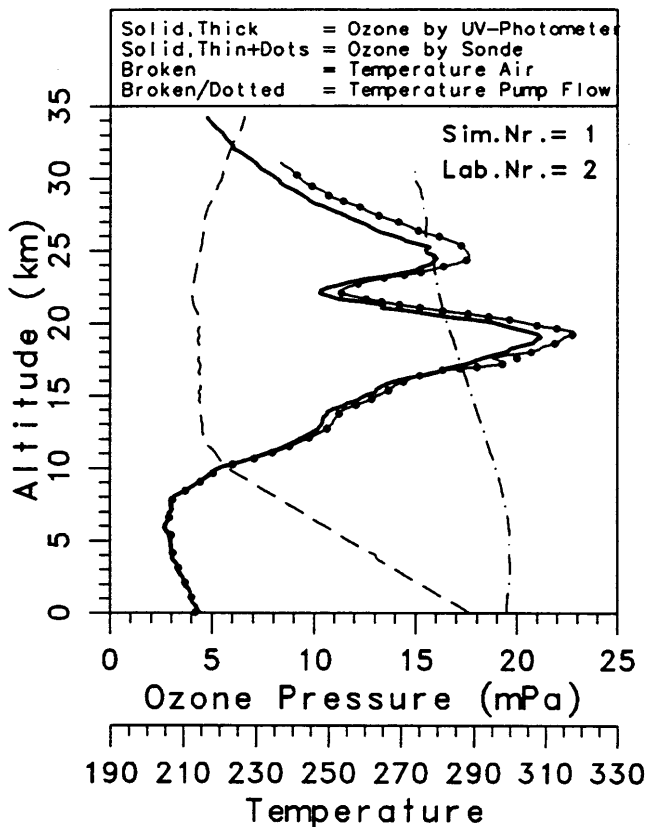

Sim.Exp.Nr. = 1 Date = 07 February 1996 Type Profile = Mid Latitude
 Part.Lab.(3) = FZJ Sonde = ECC/SPC-6A

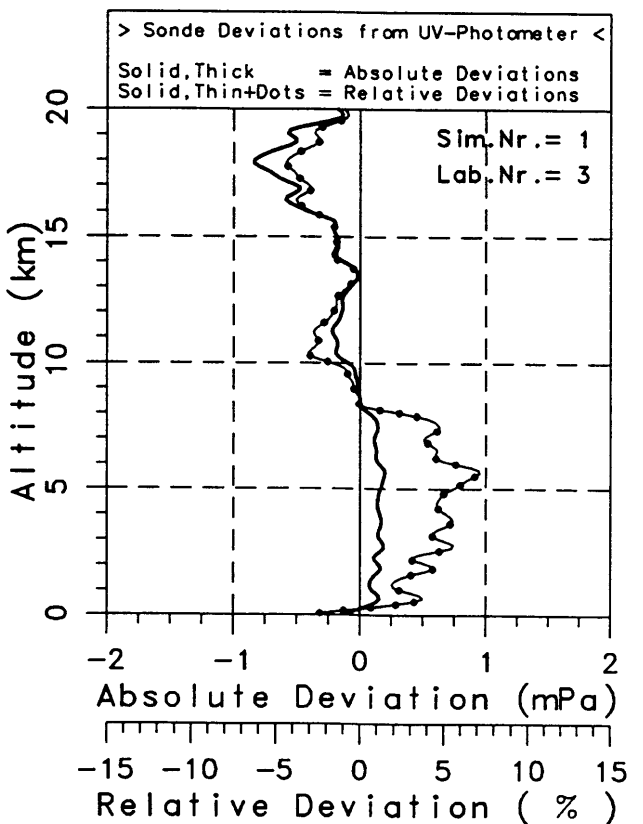
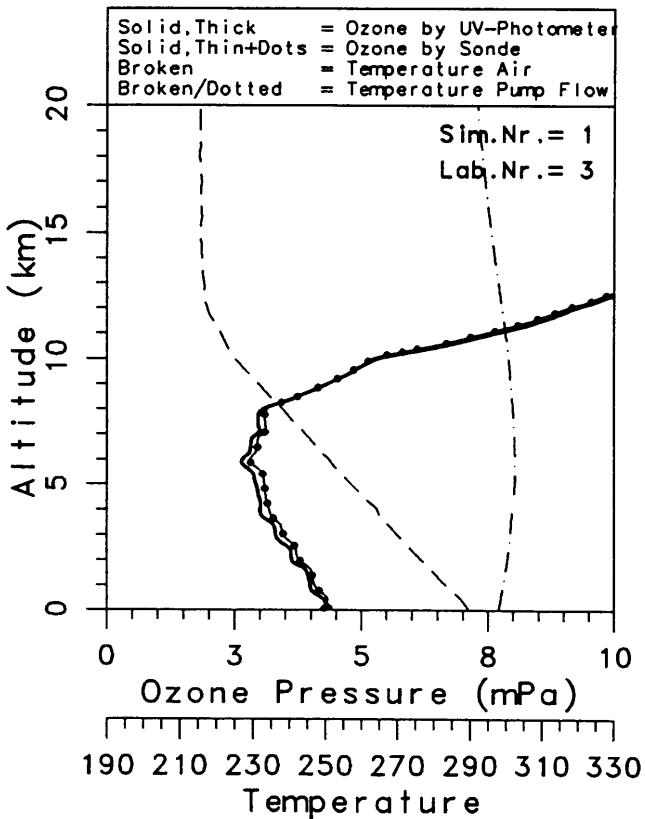
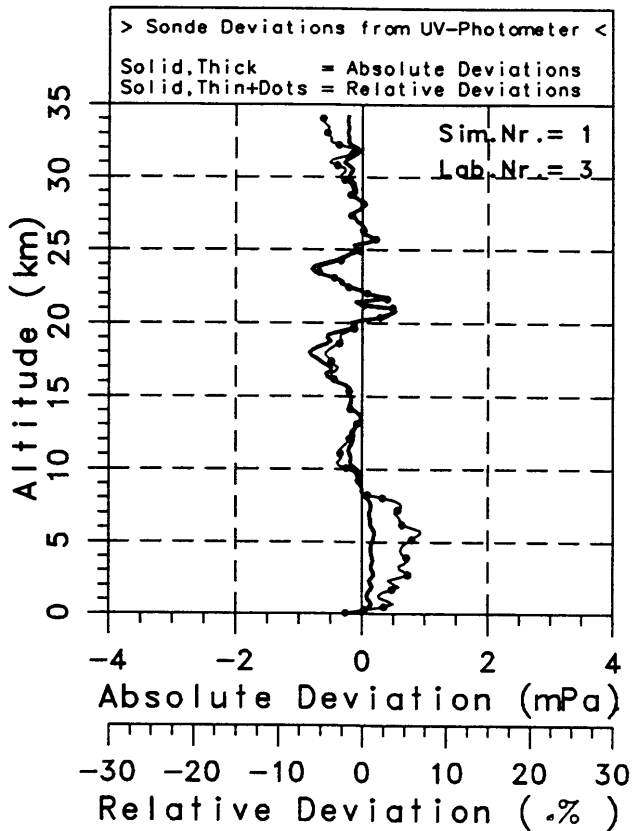
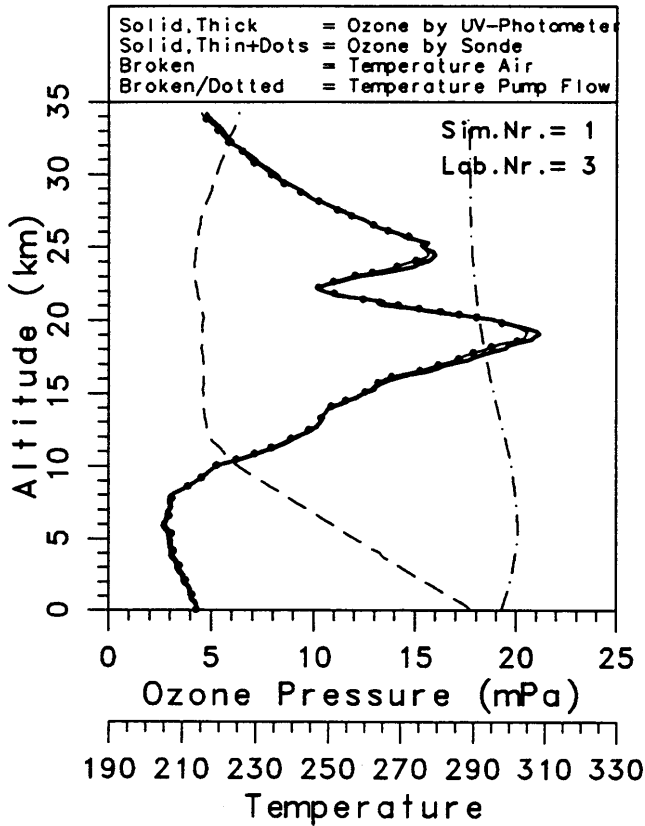

Sim.Exp.Nr. = 1 Date = 07 February 1996 Type Profile = Mid Latitude
 Part.Lab.(4) = IMD Sonde = BM/IMD-Hybrid

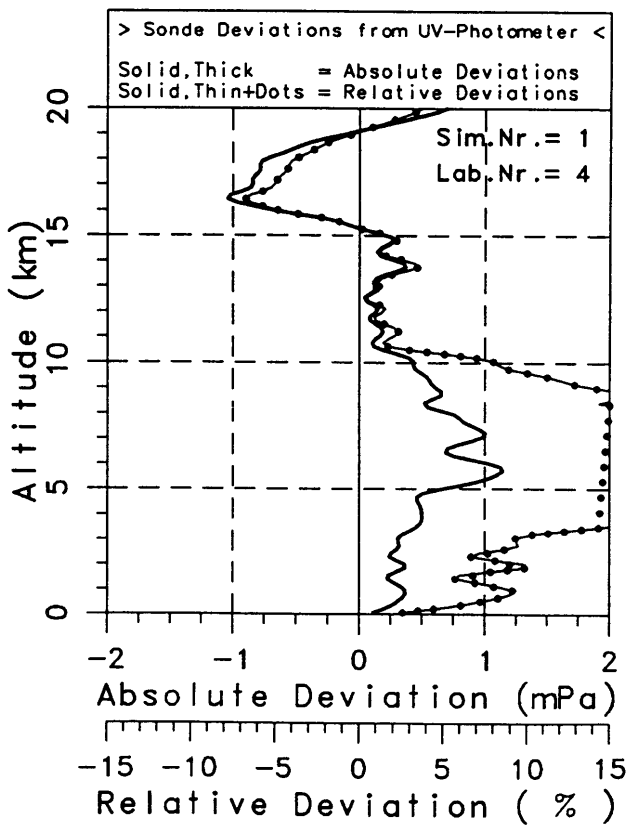
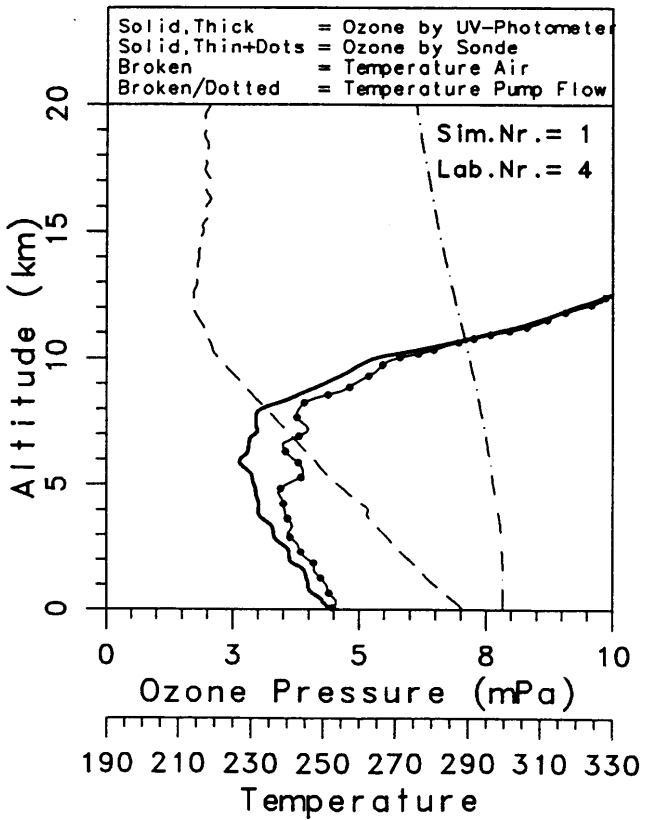
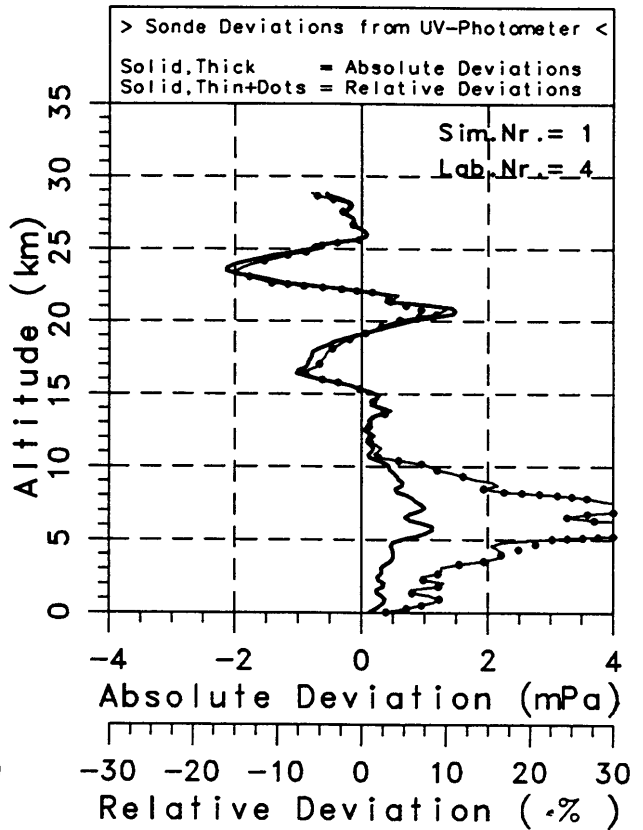
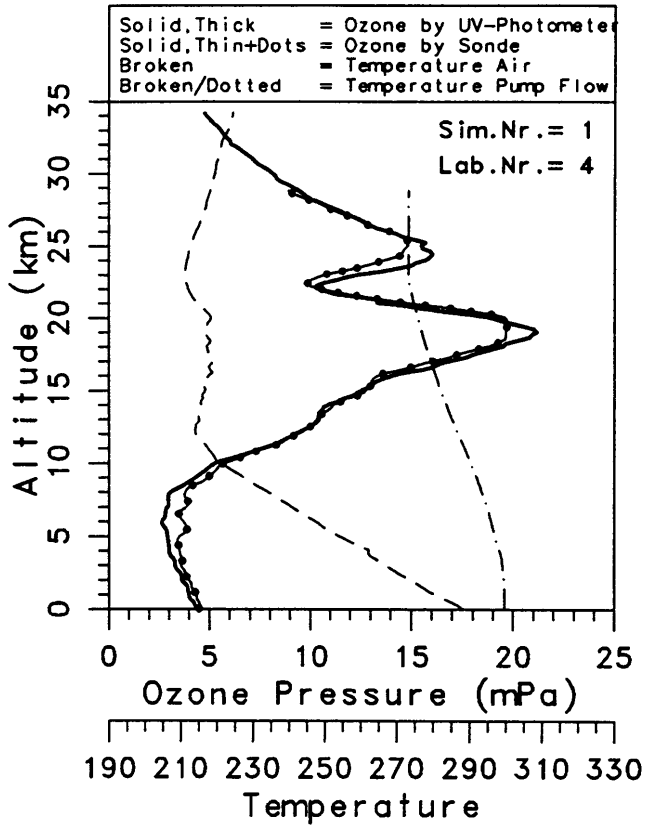

Sim.Exp.Nr. = 2 Date = 08 February 1996 Type Profile = Mid Latitude
 Part.Lab.(1) = MOHp Sonde = BM/Original

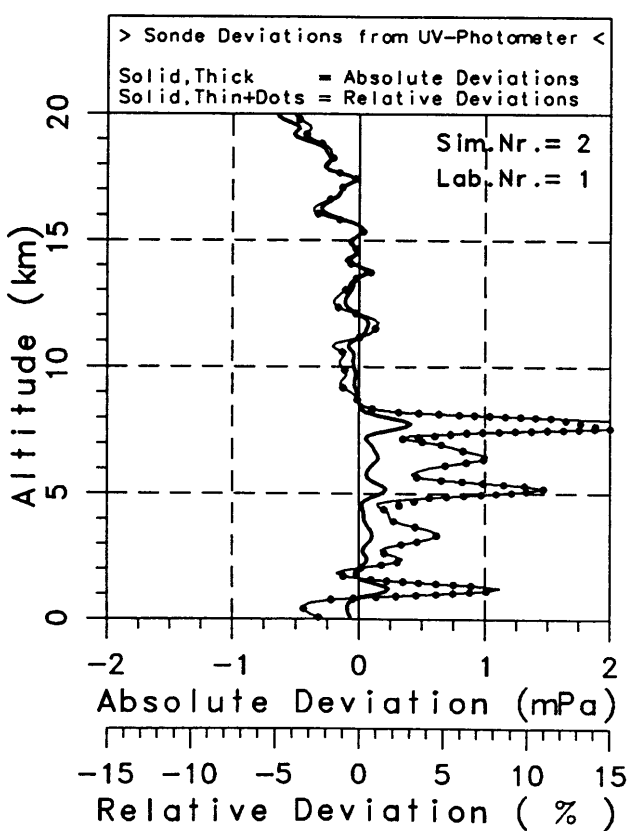
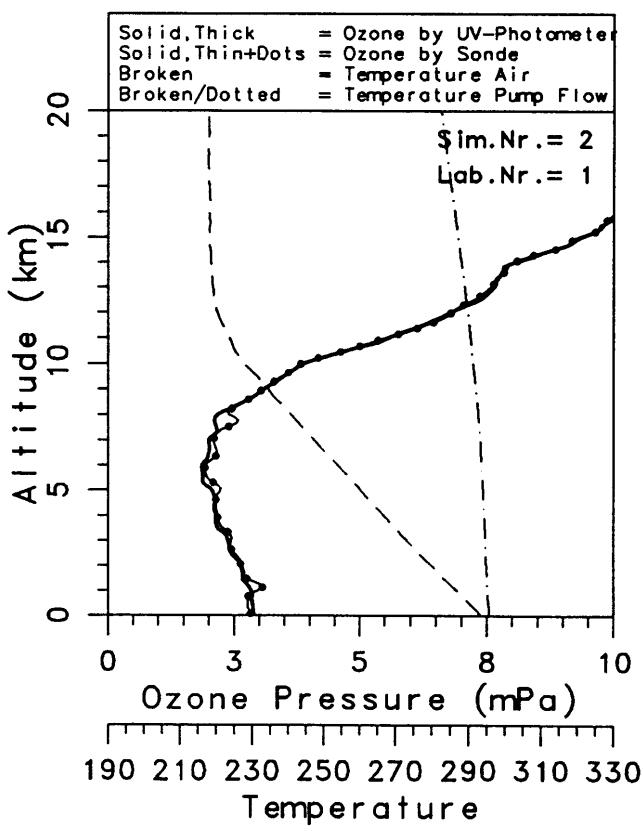
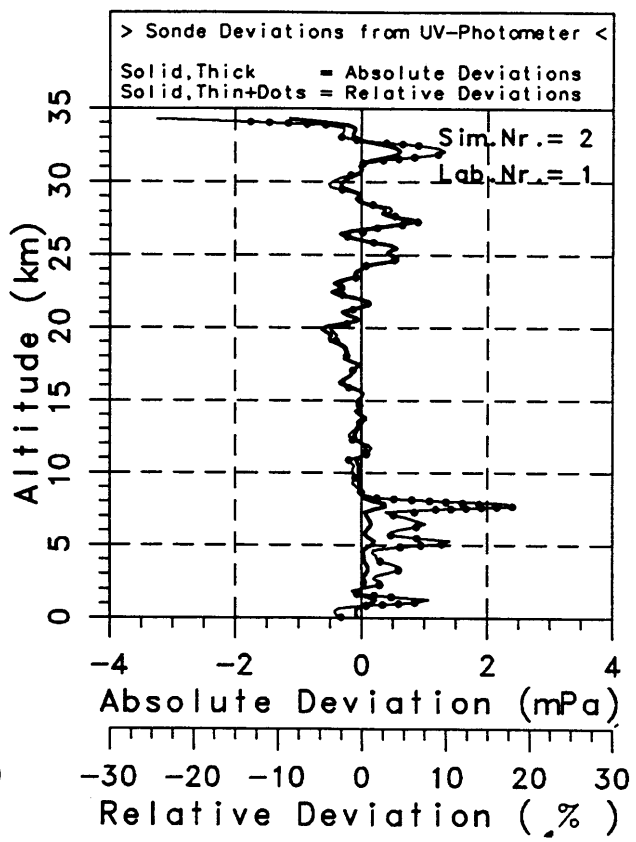
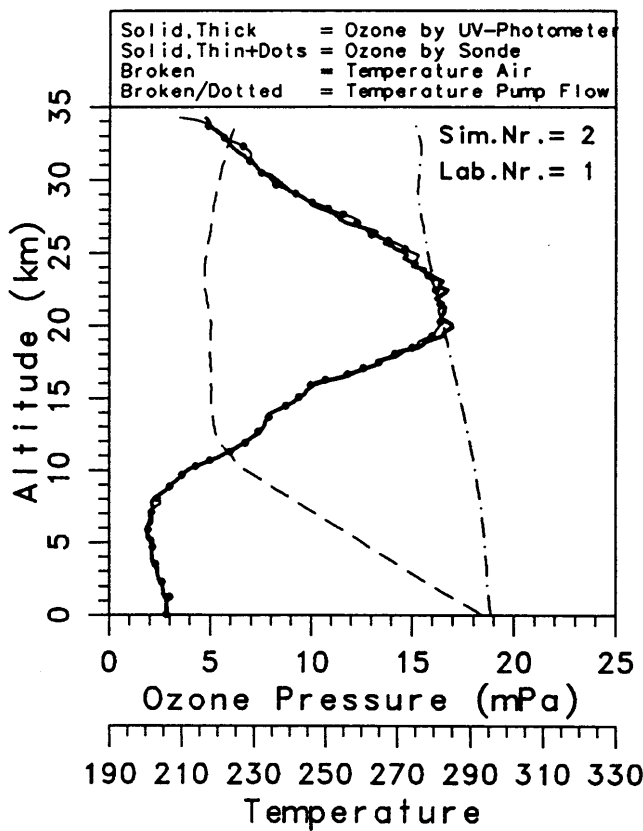

Sim.Exp.Nr. = 2 Date = 08 February 1996 Type Profile = Mid Latitude

Part.Lab.(2) = NOAA/CMDL Sonde = ECC/ENSCI-1Z

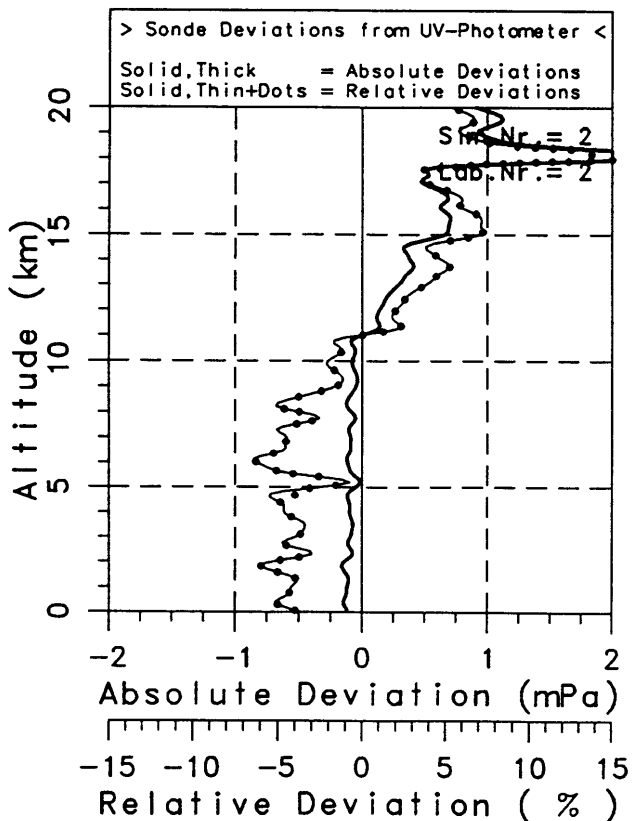
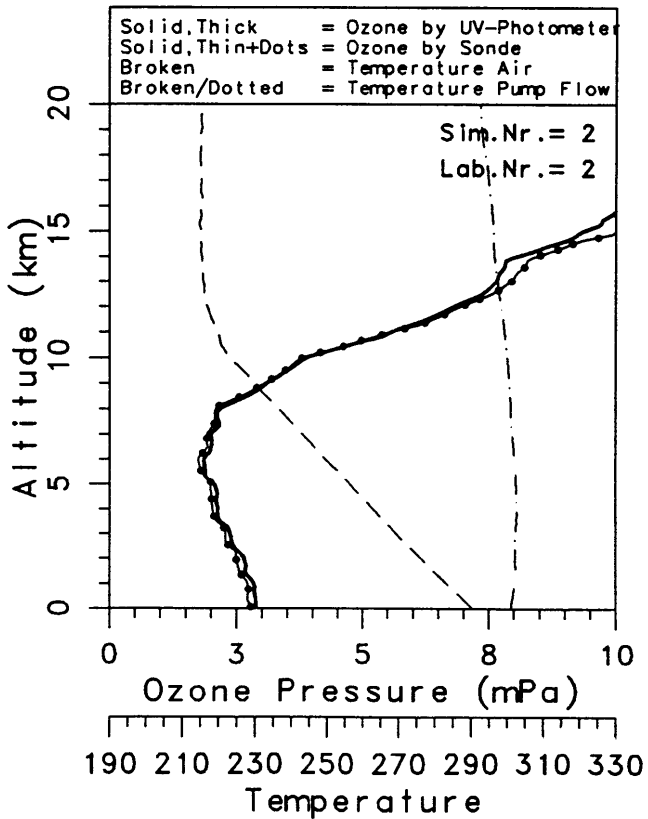
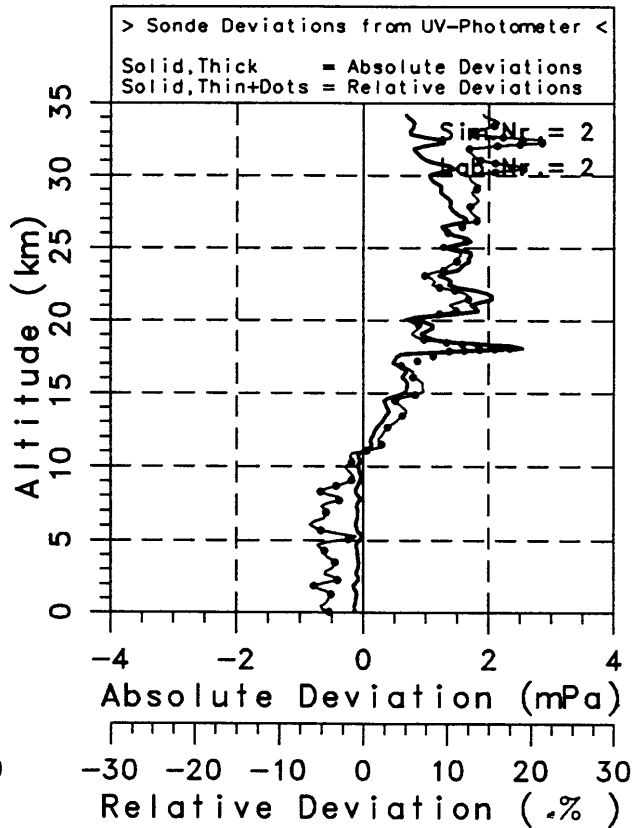
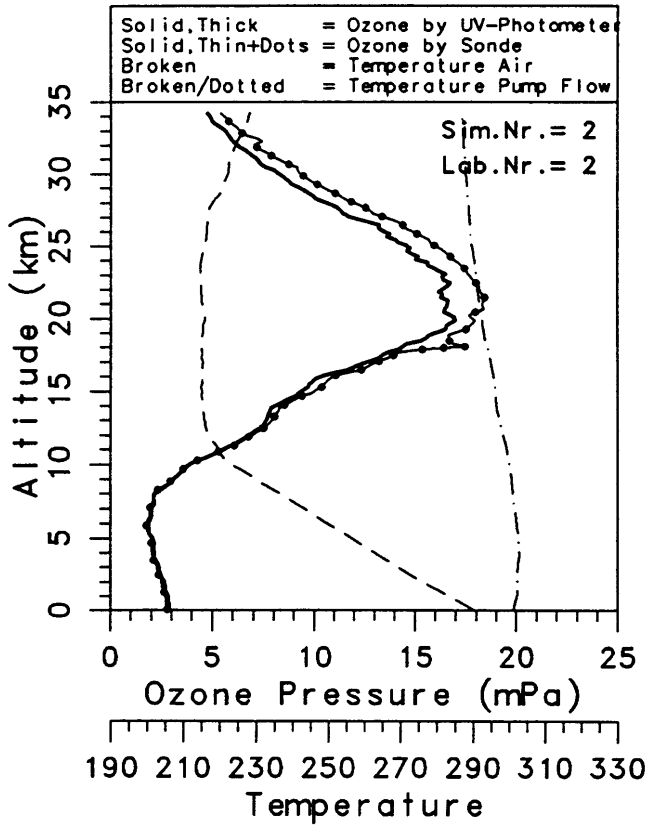

Sim.Exp.Nr. = 2 Date = 08 February 1996 Type Profile = Mid Latitude
 Part.Lab.(3) = FZJ Sonde = ECC/SPC-6A

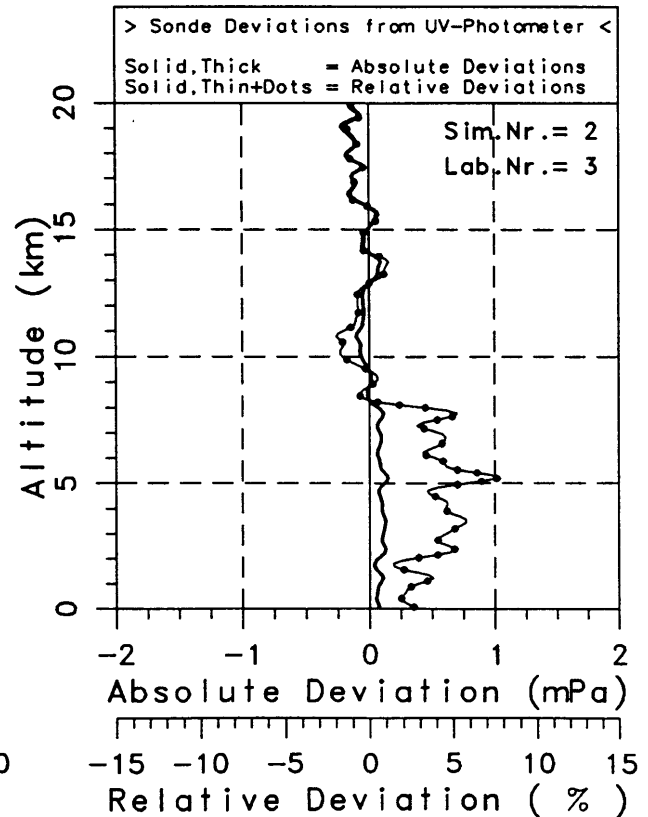
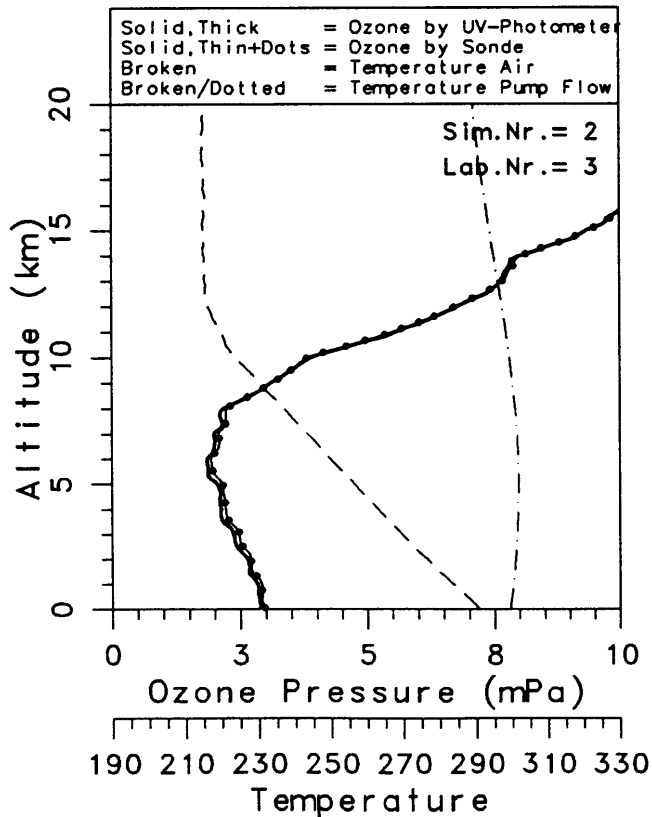
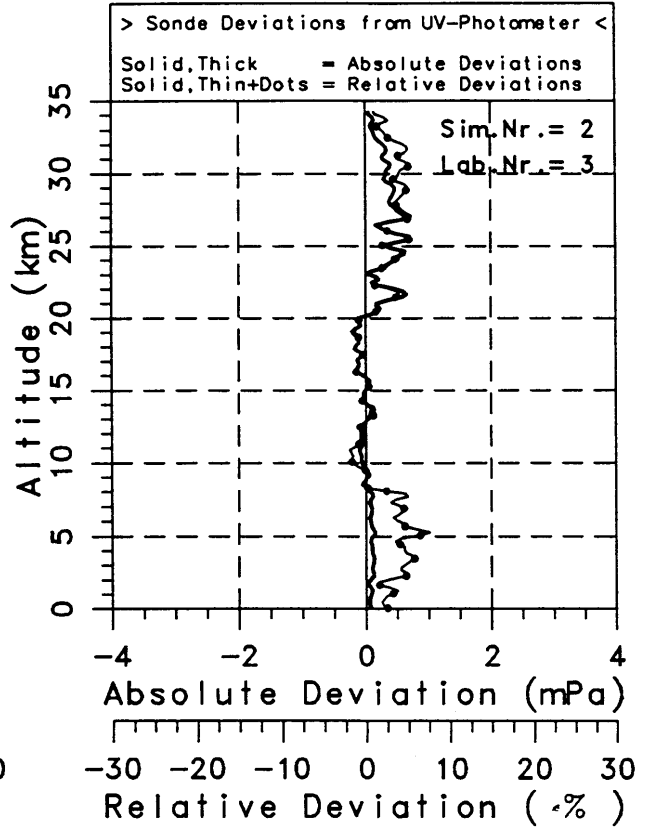
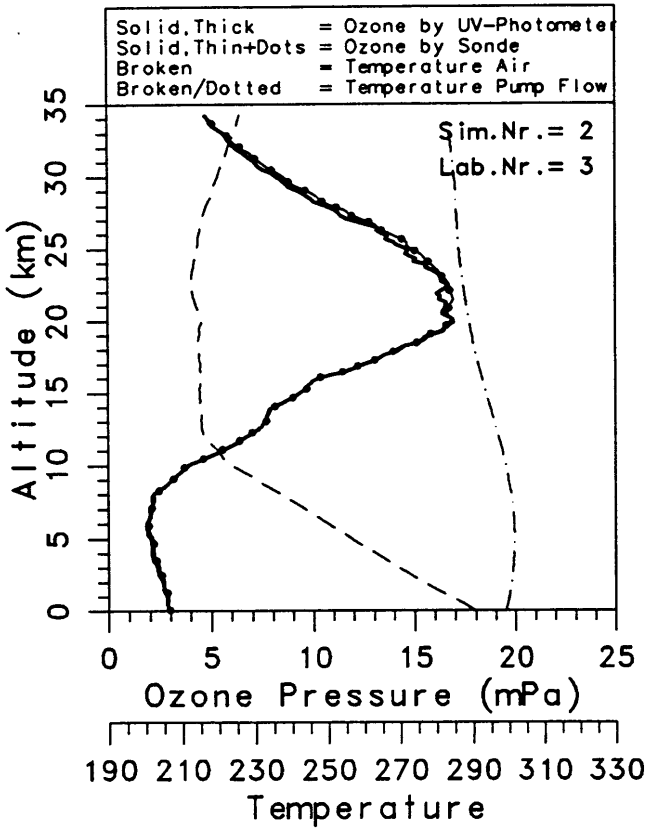

Sim.Exp.Nr. = 2 Date = 08 February 1996 Type Profile = Mid Latitude

Part.Lab.(4) = IMD

Sonde = BM/IMD-Hybrid

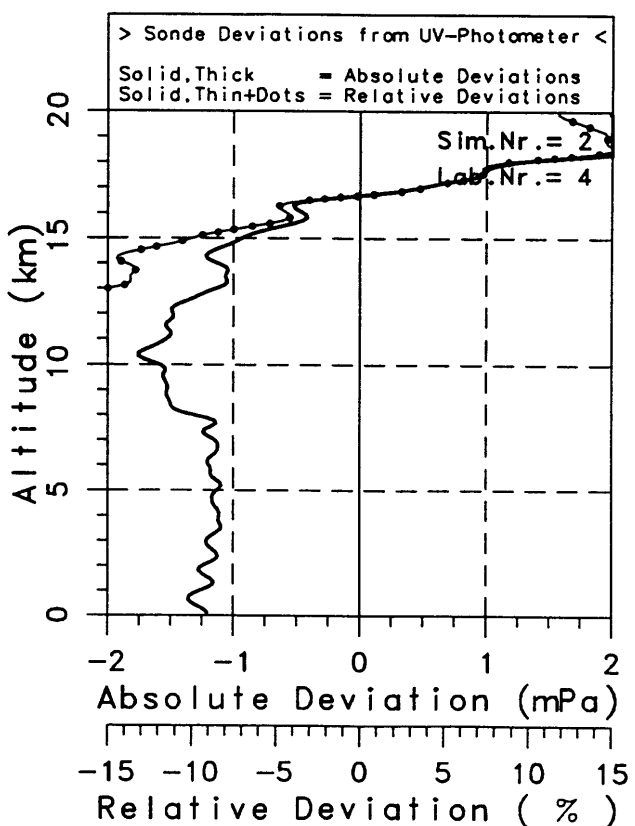
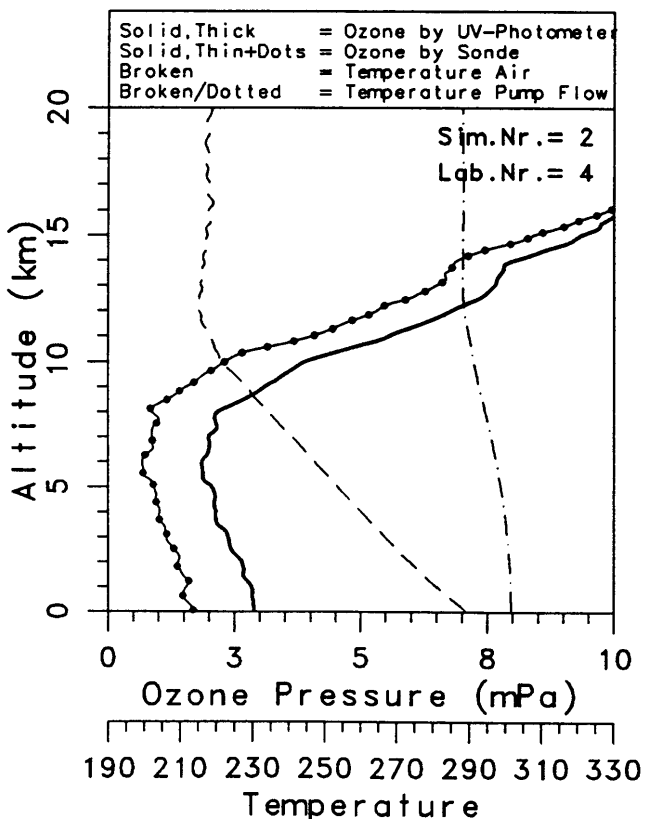
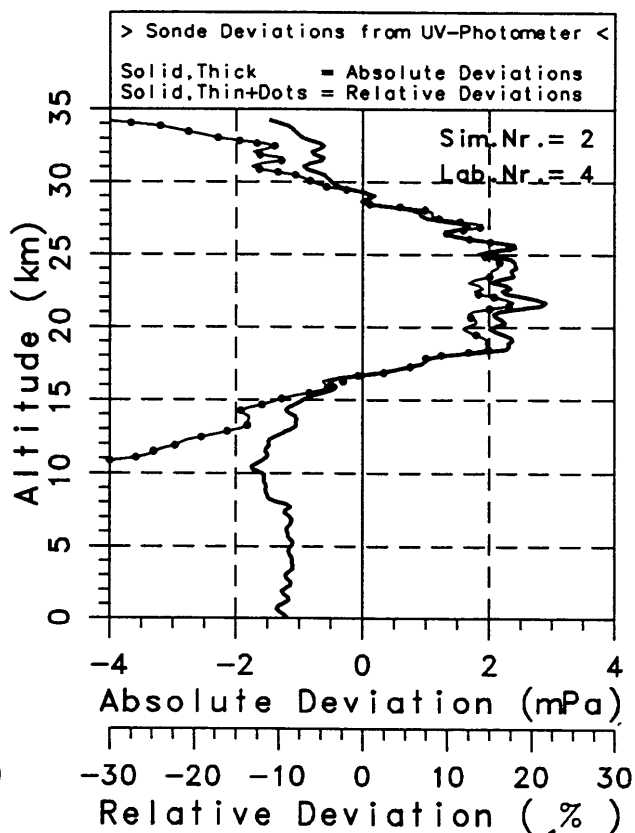
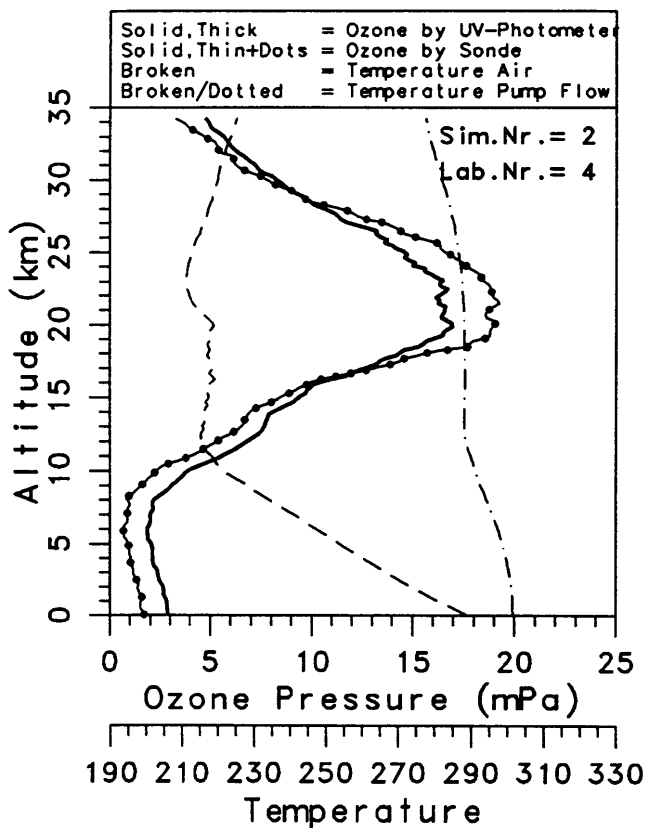

Sim.Exp.Nr. = 3 Date = 09 February 1996 Type Profile = Mid Latitude
 Part.Lab.(2) = NOAA/CMDL Sonde = ECC/ENSCI-1Z

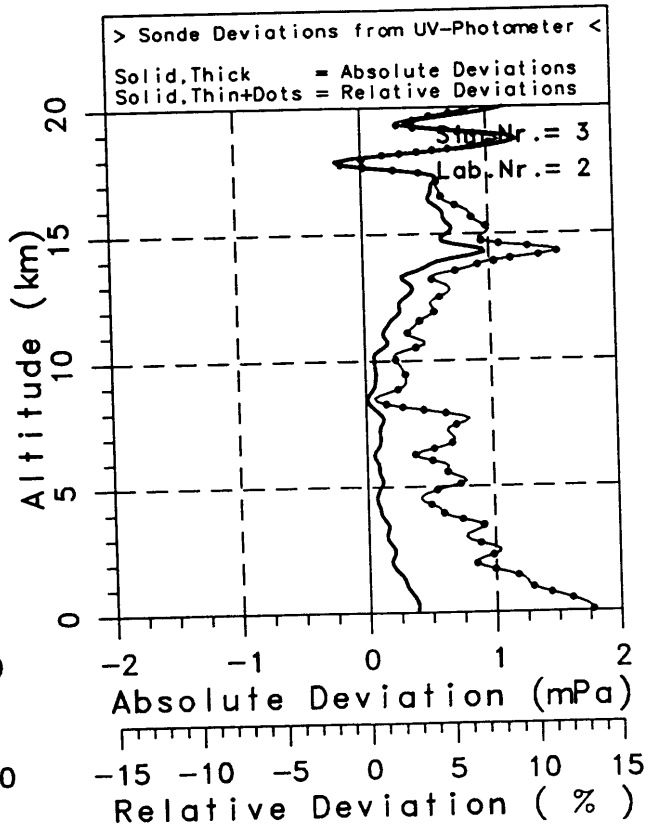
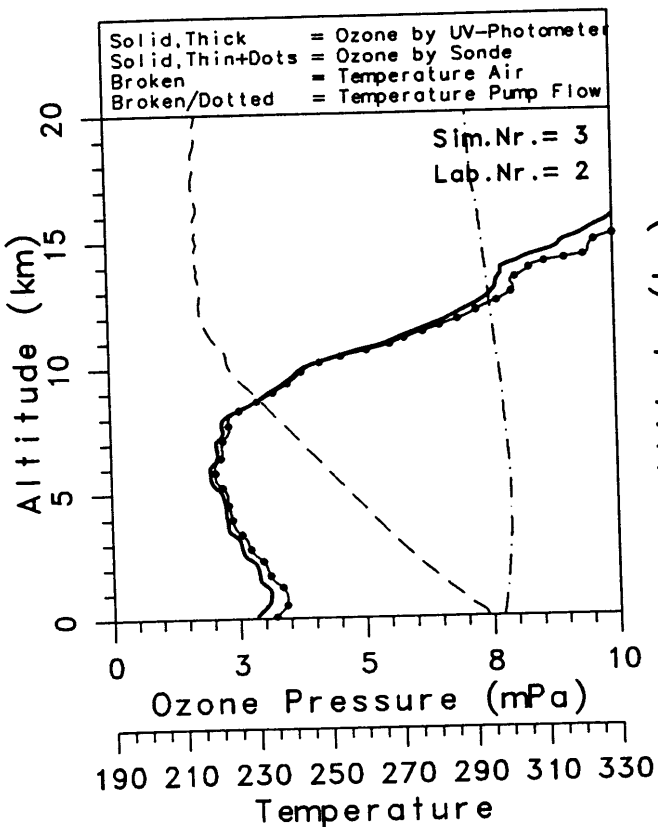
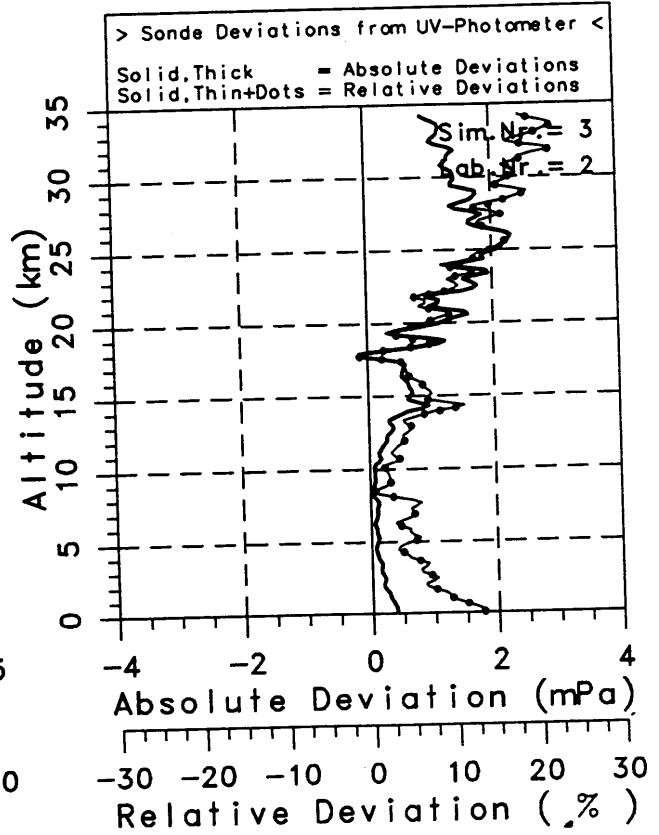
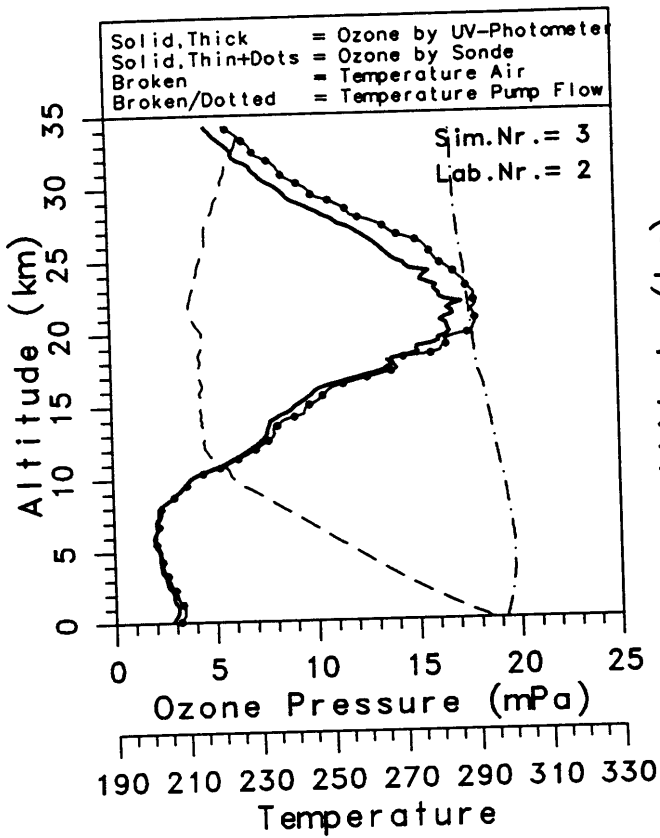

Sim.Exp.Nr. = 3 Date = 09 February 1996 Type Profile = Mid Latitude
 Part.Lab.(4) = IMD Sonde = BM/IMD-Hybrid

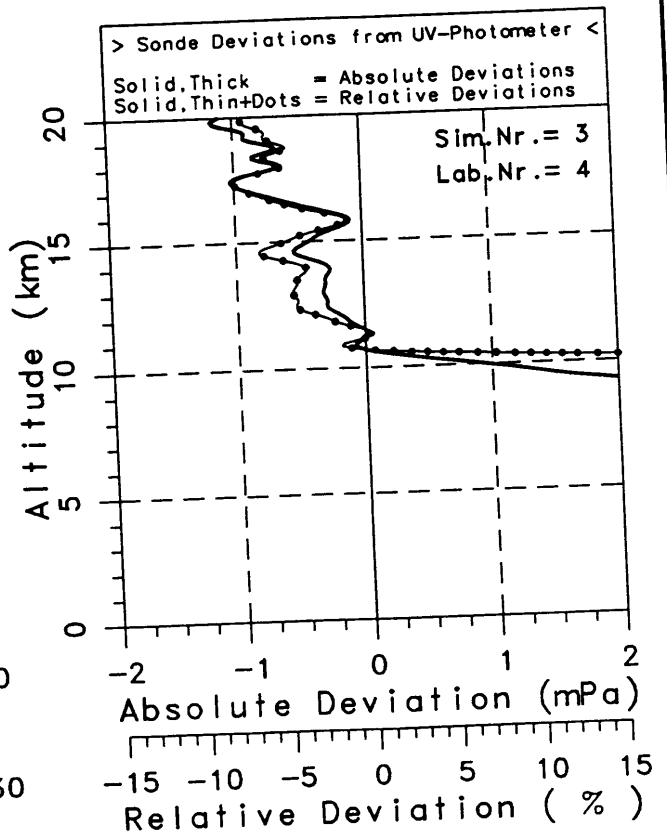
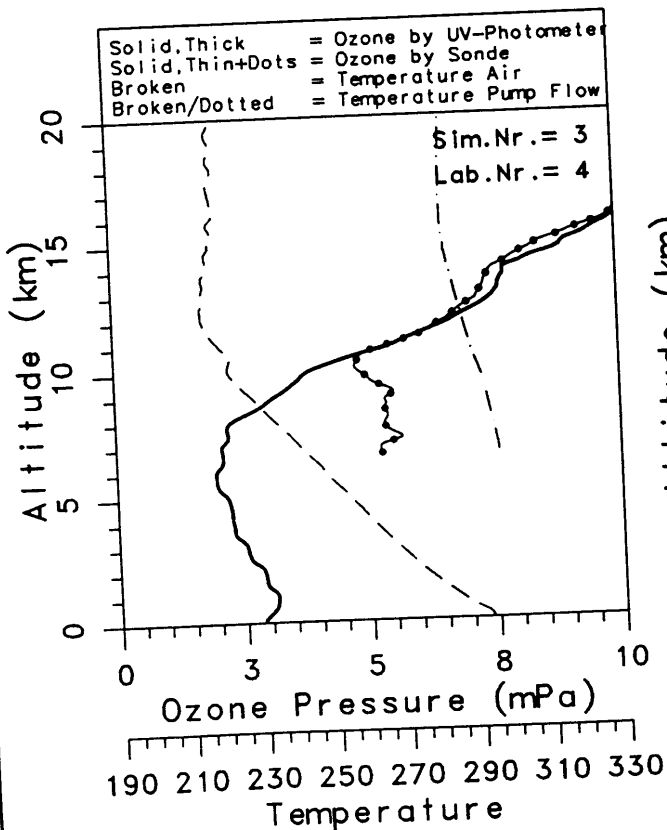
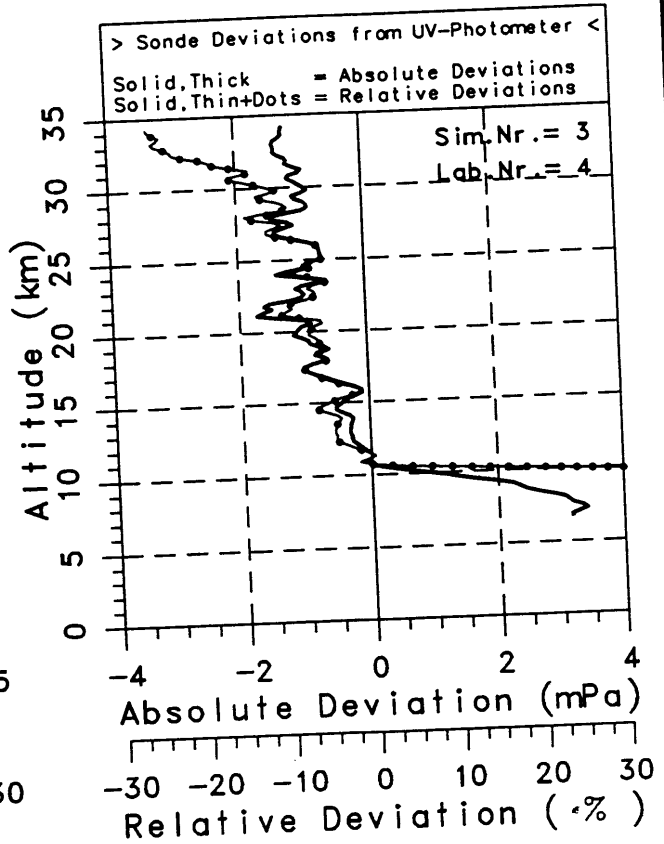
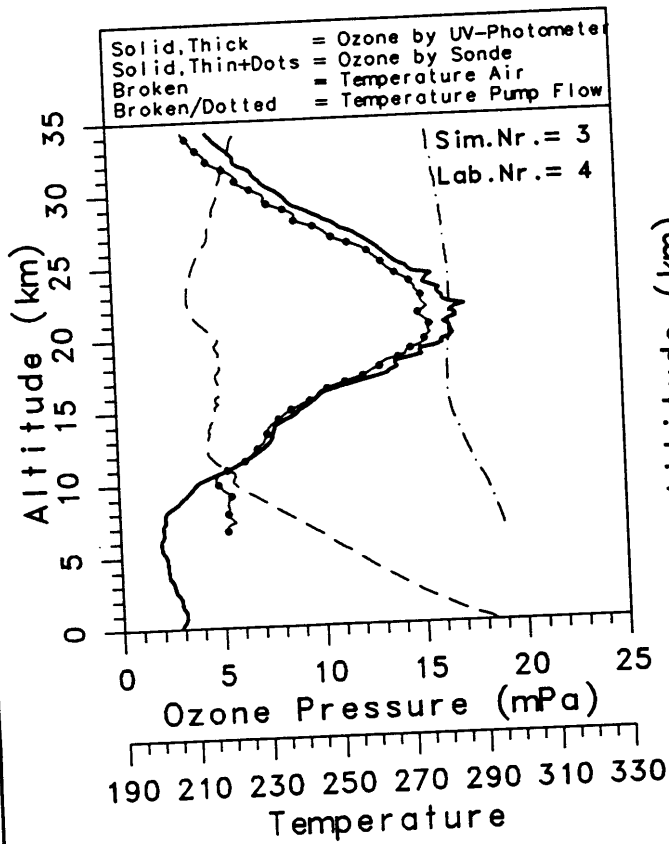

Sim.Exp.Nr. = 5 Date = 13 February 1996 Type Profile = Tropics
 Part.Lab.(4) = IMD Sonde = BM/IMD-Hybrid

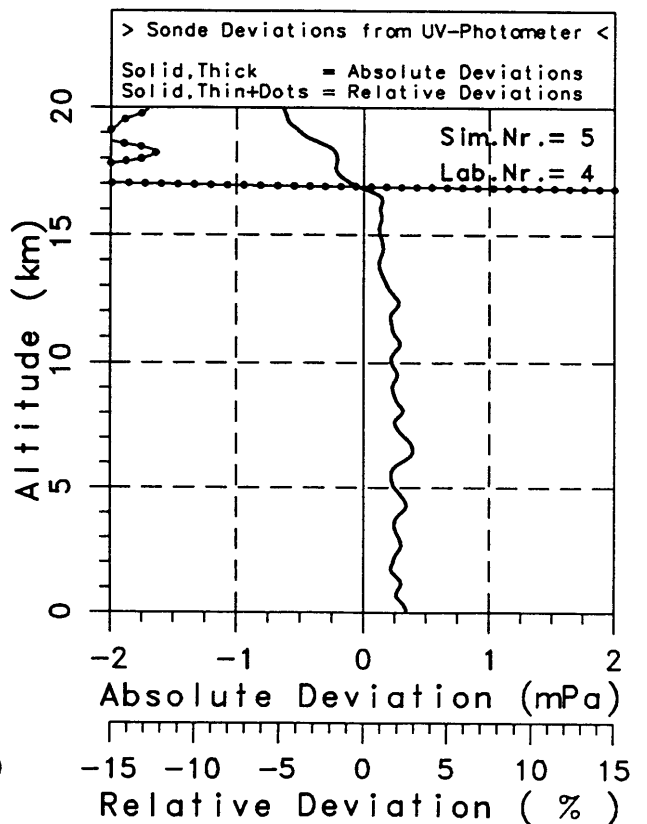
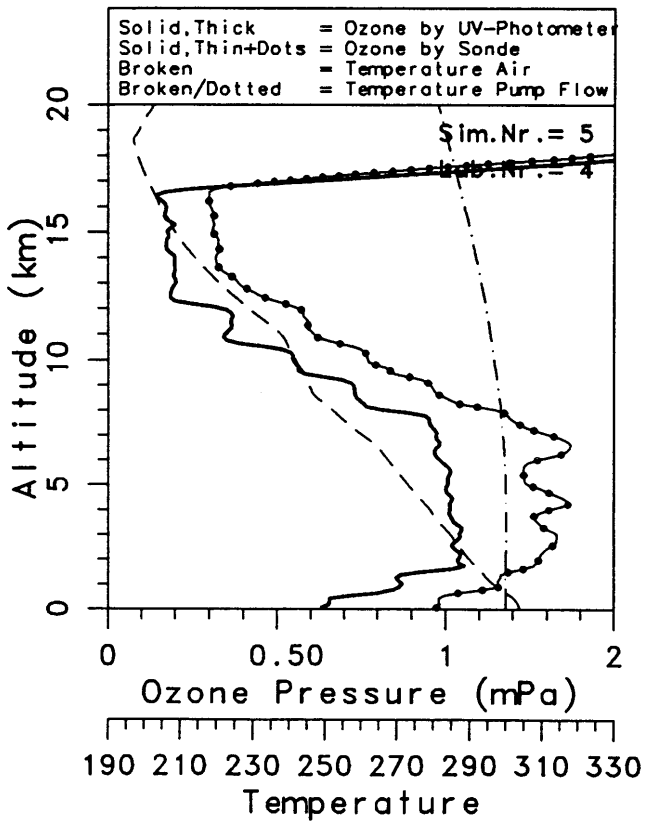
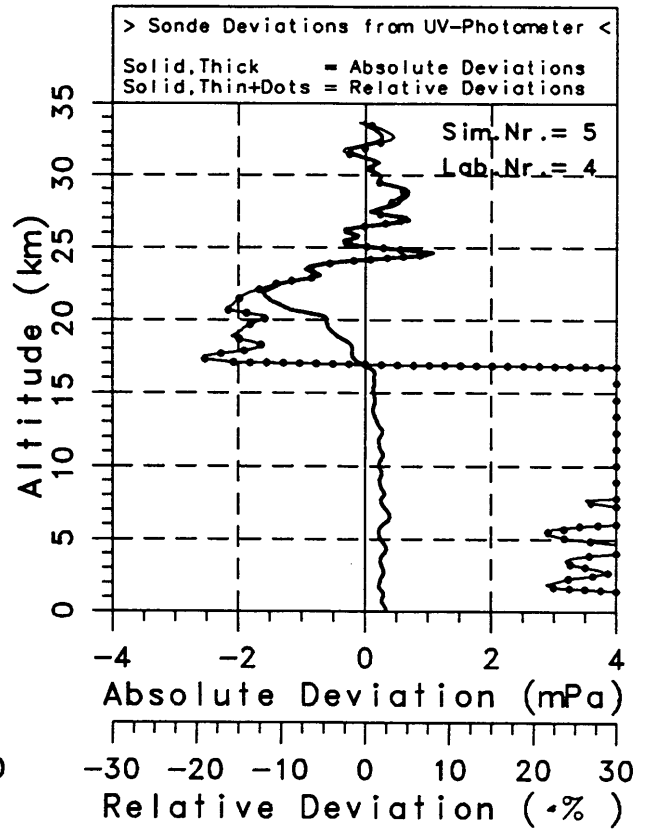
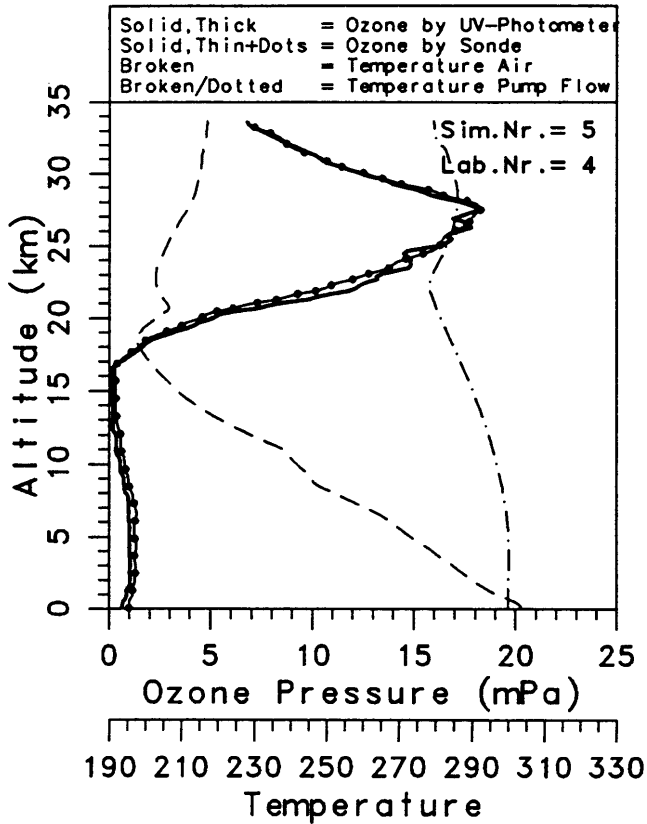

Sim.Exp.Nr. = 6 Date = 14 February 1996 Type Profile = Mid Latitude

Part.Lab.(1) = MOHp

Sonde = BM/Original

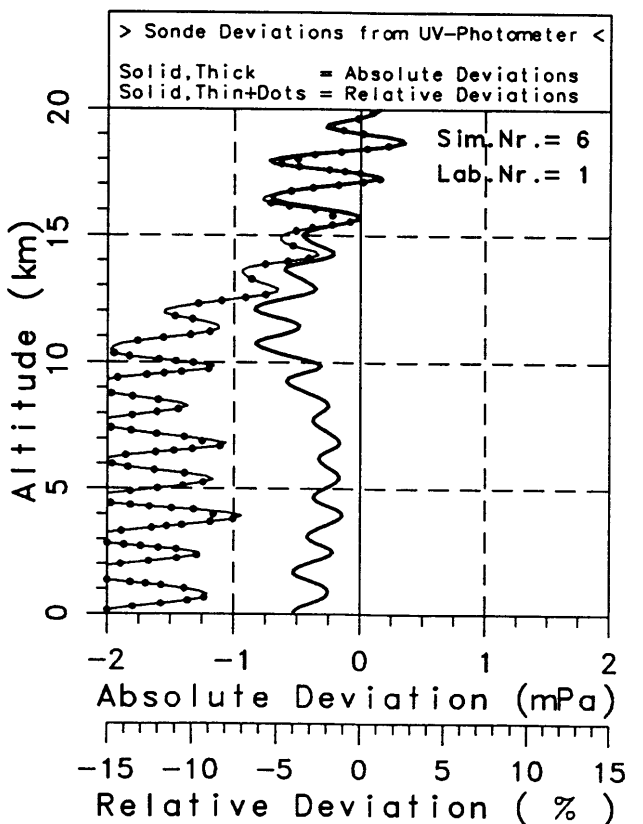
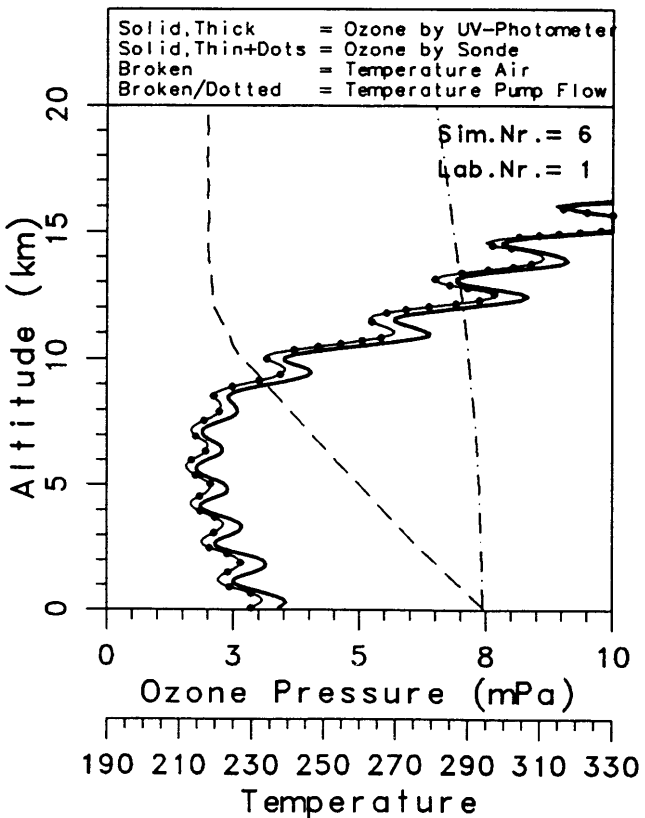
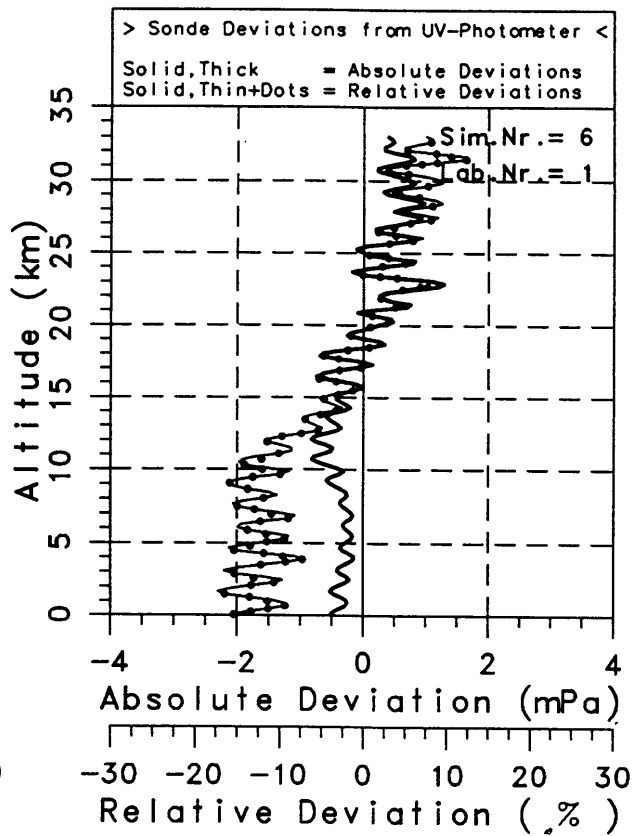
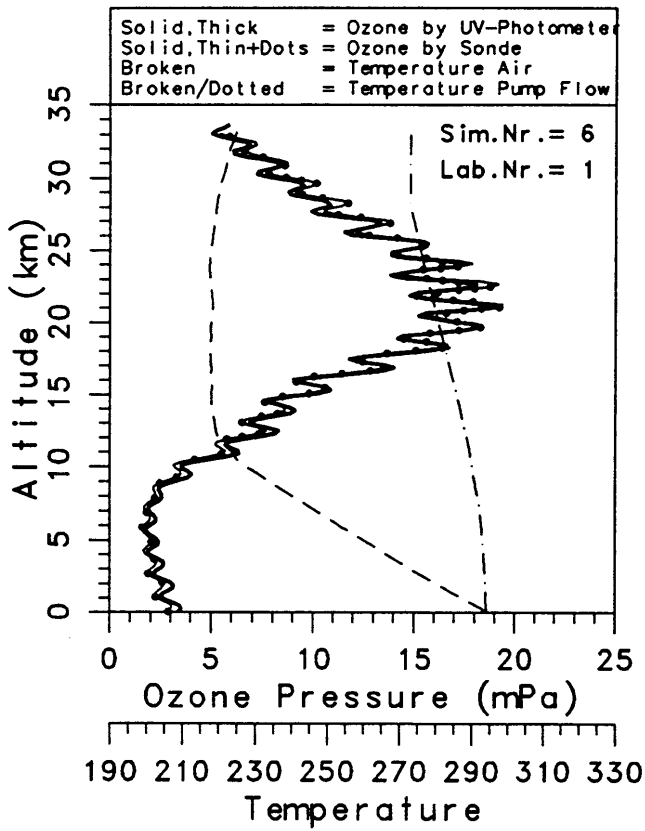

Sim.Exp.Nr. = 6 Date = 14 February 1996 Type Profile = Mid Latitude
 Part.Lab.(2) = NOAA/CMDL Sonde = ECC/ENSCI-1Z

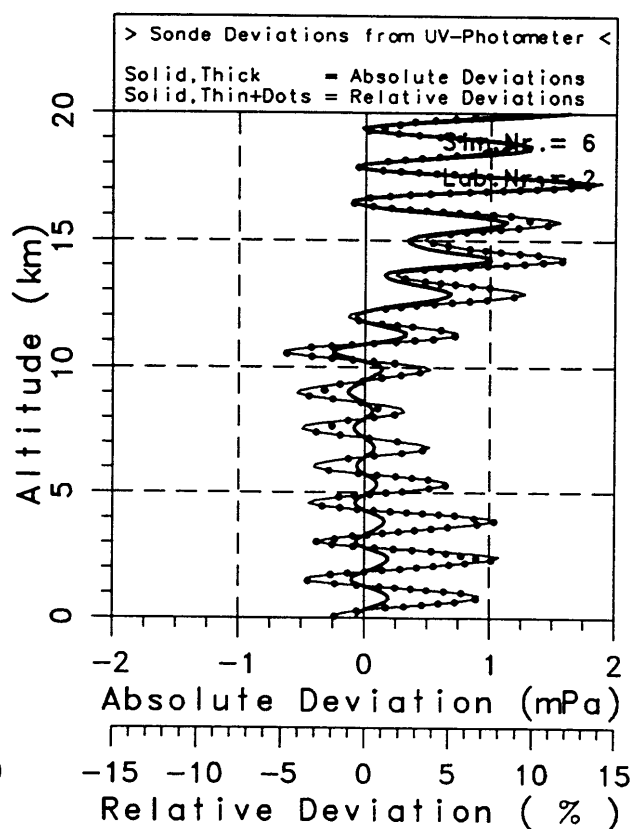
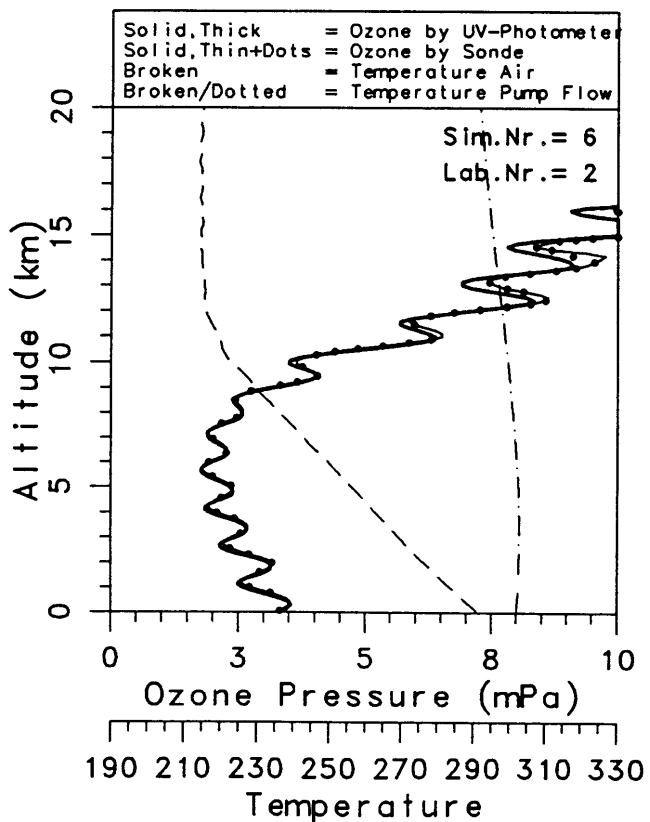
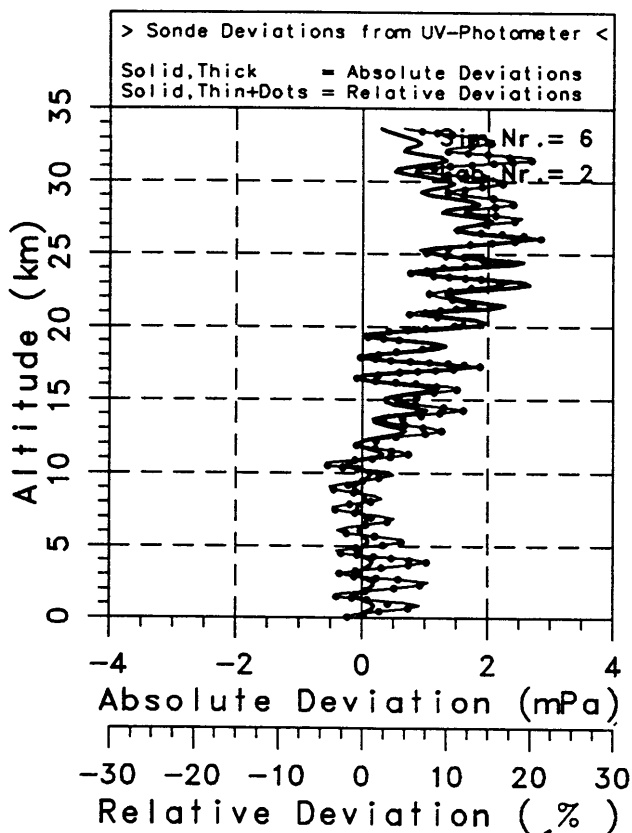
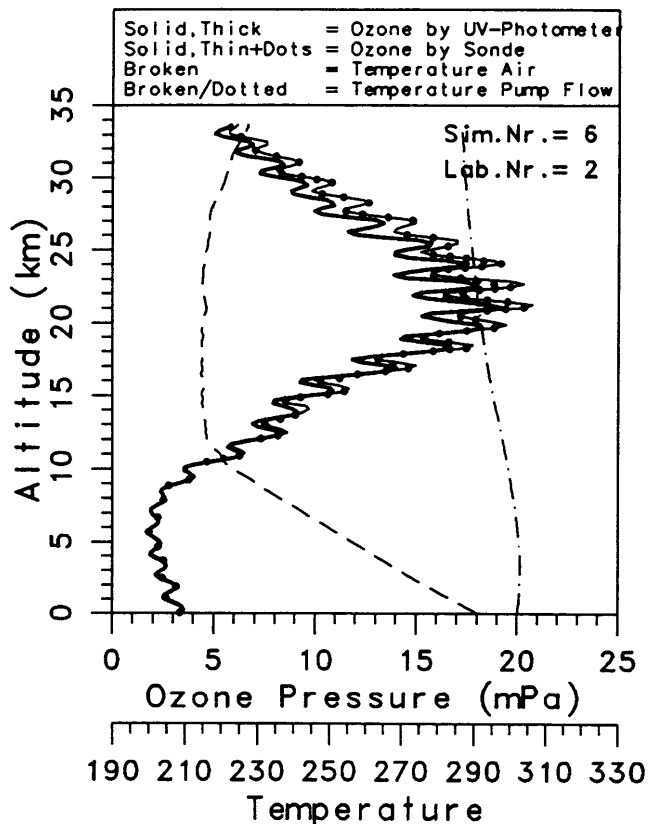

Sim.Exp.Nr. = 6 Date = 14 February 1996 Type Profile = Mid Latitude
 Part.Lab.(3) = FZJ Sonde = ECC/SPC-6A

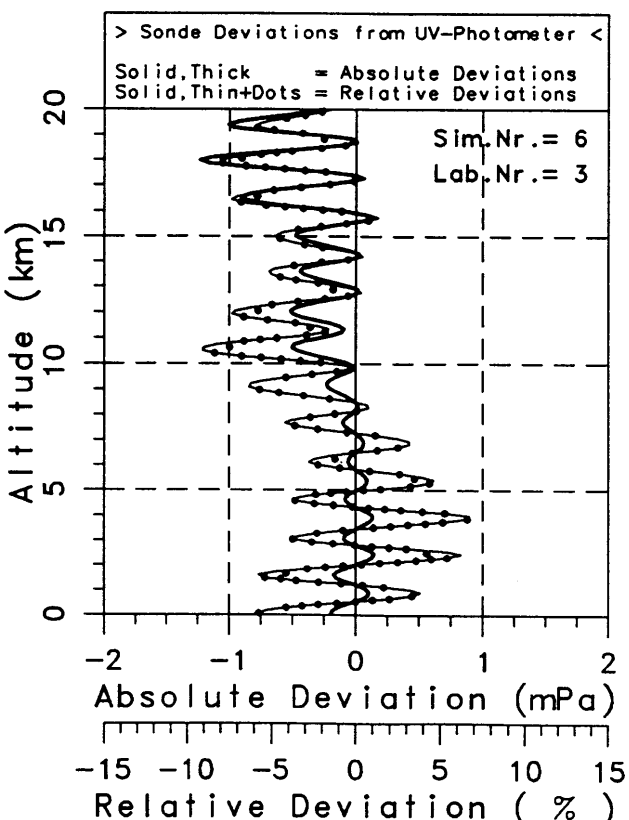
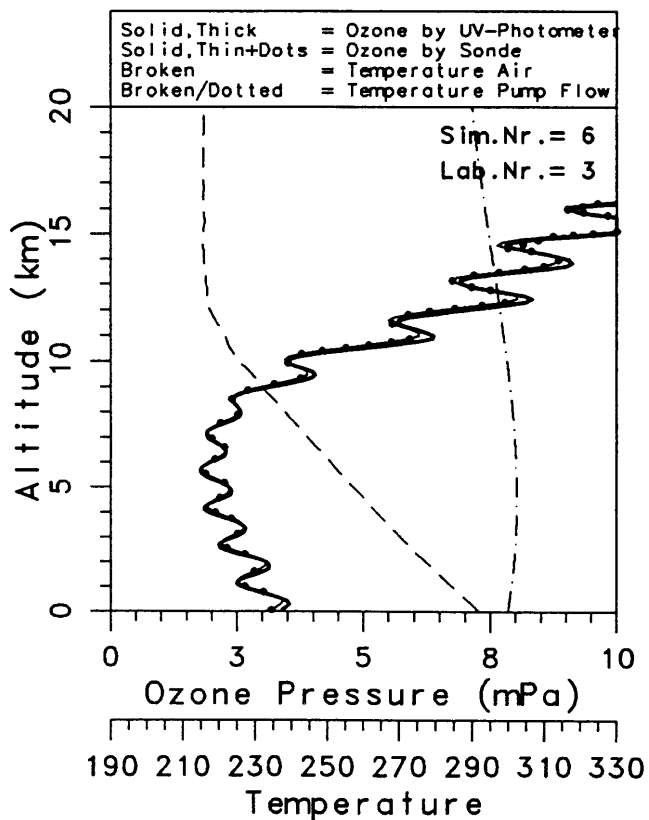
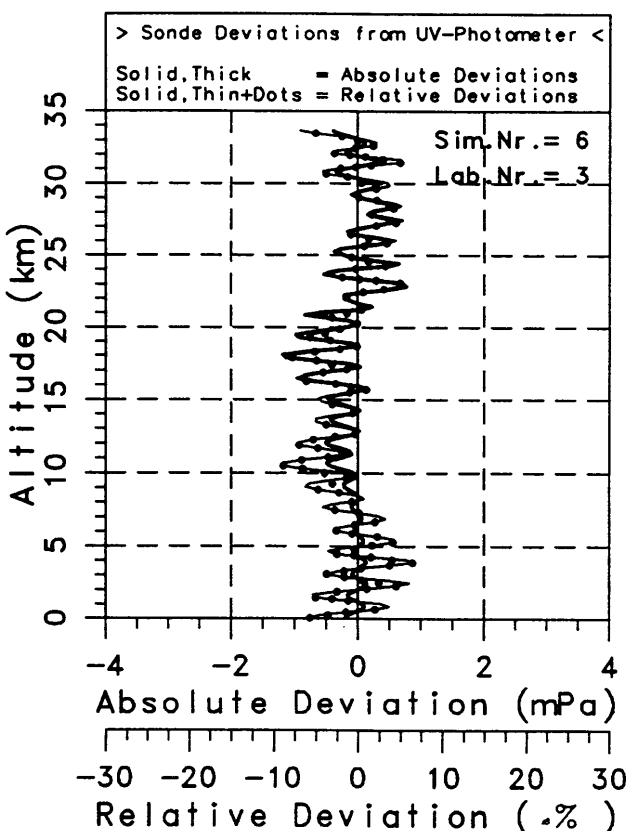
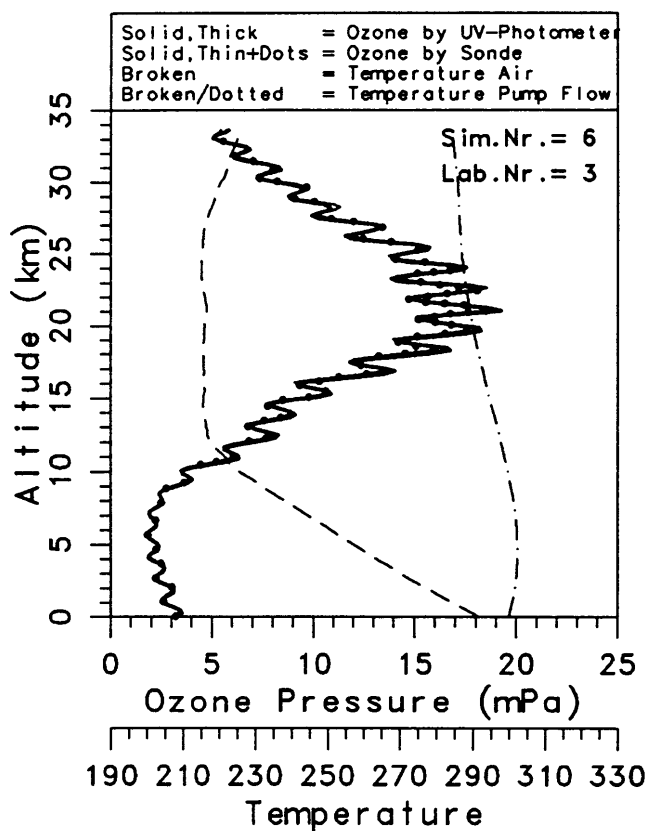

Sim.Exp.Nr. = 6 Date = 14 February 1996 Type Profile = Mid Latitude
 Part.Lab.(4) = IMD Sonde = BM/IMD-Hybrid

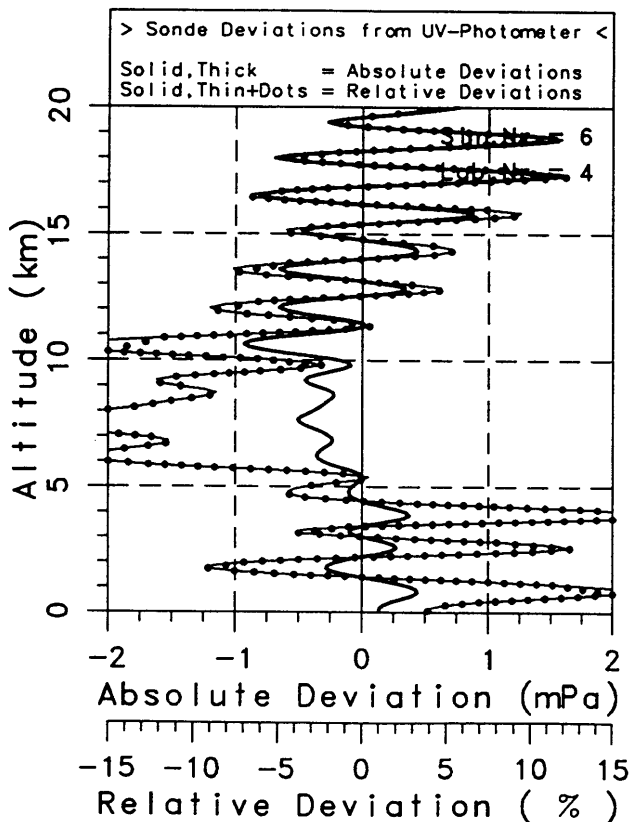
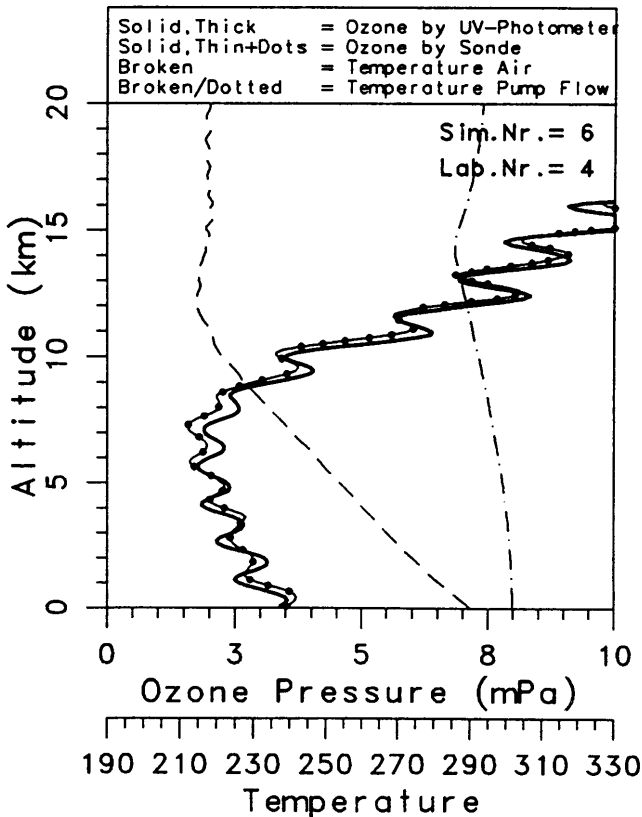
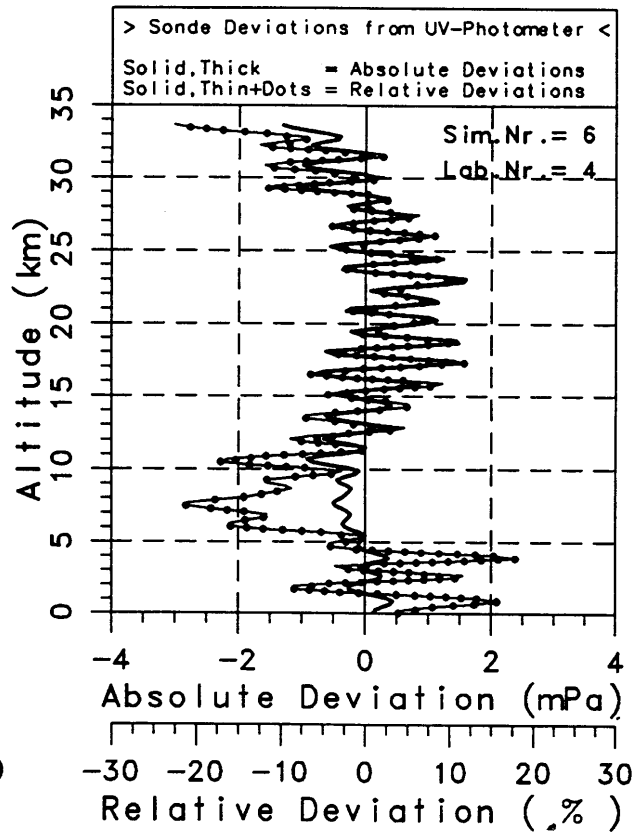
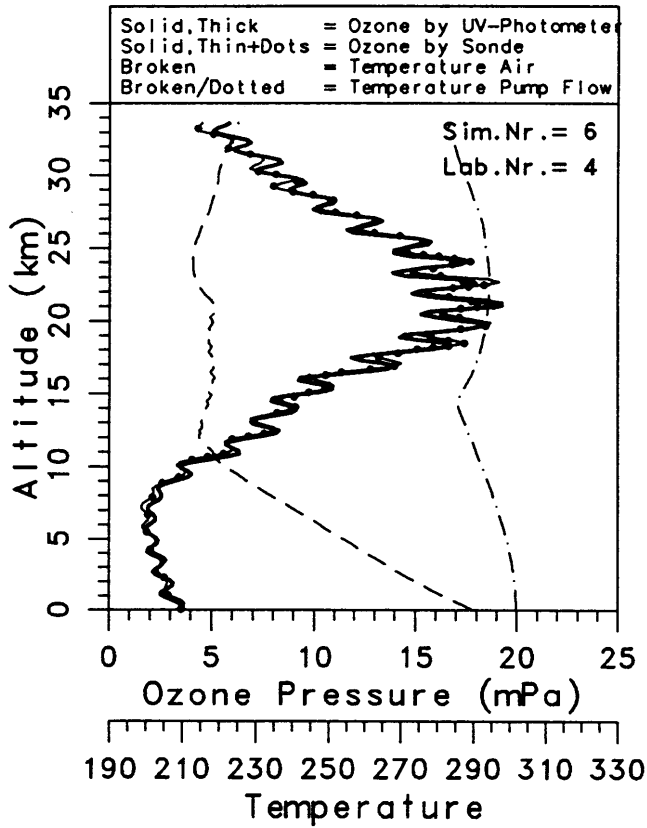

Sim.Exp.Nr. = 7 Date = 28 February 1996 Type Profile = Mid Latitude
 Part.Lab.(5) = ASP Sonde = BM/ECC-Hybrid

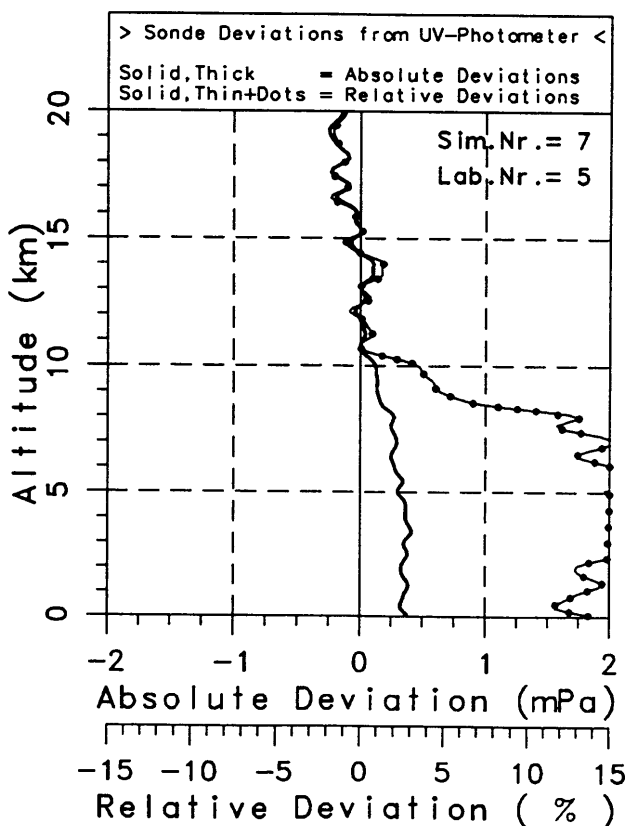
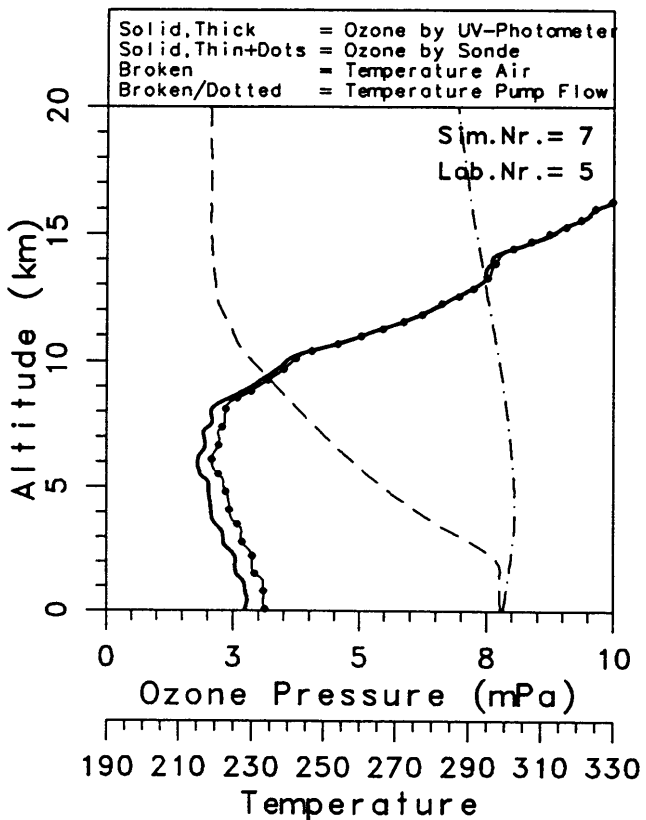
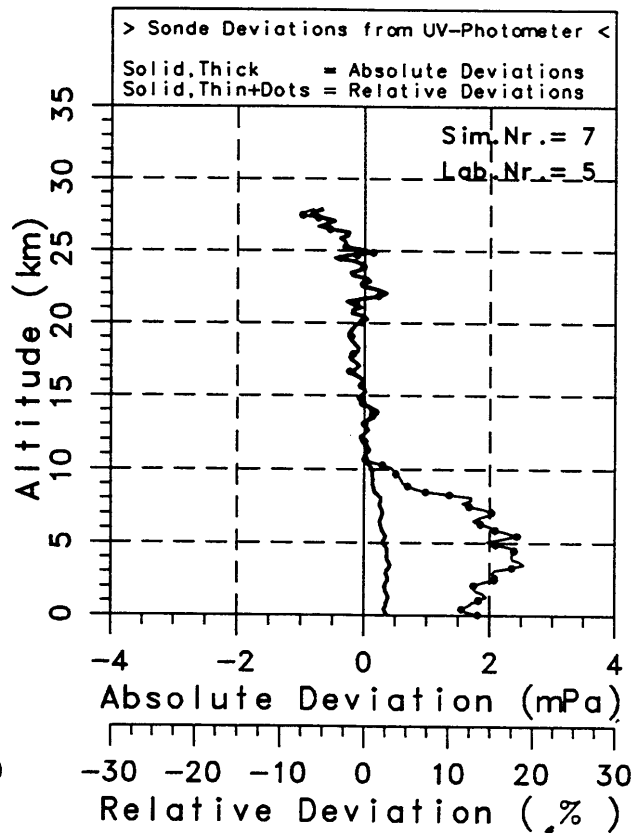
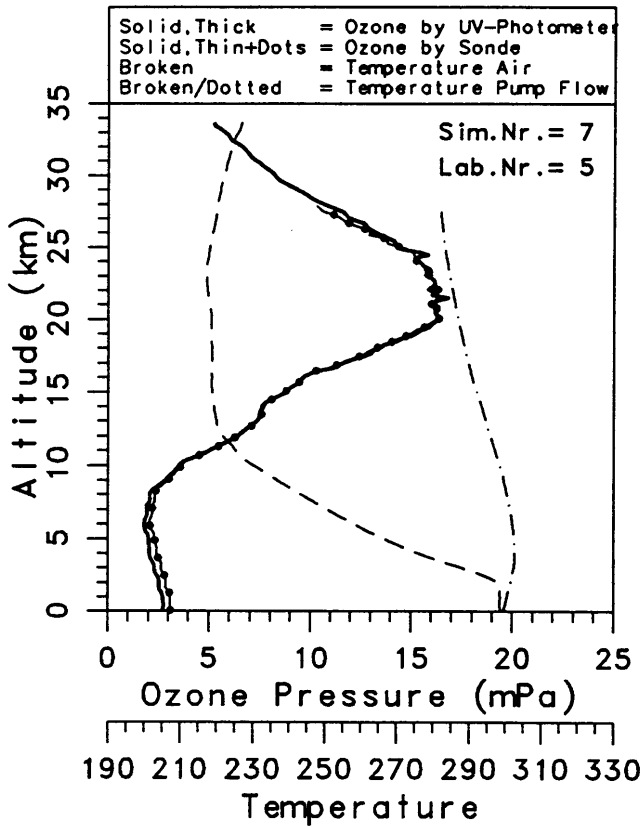

Sim.Exp.Nr. = 7 Date = 28 February 1996 Type Profile = Mid Latitude
 Part.Lab.(6) = AES Sonde = ECC/SPC-5A

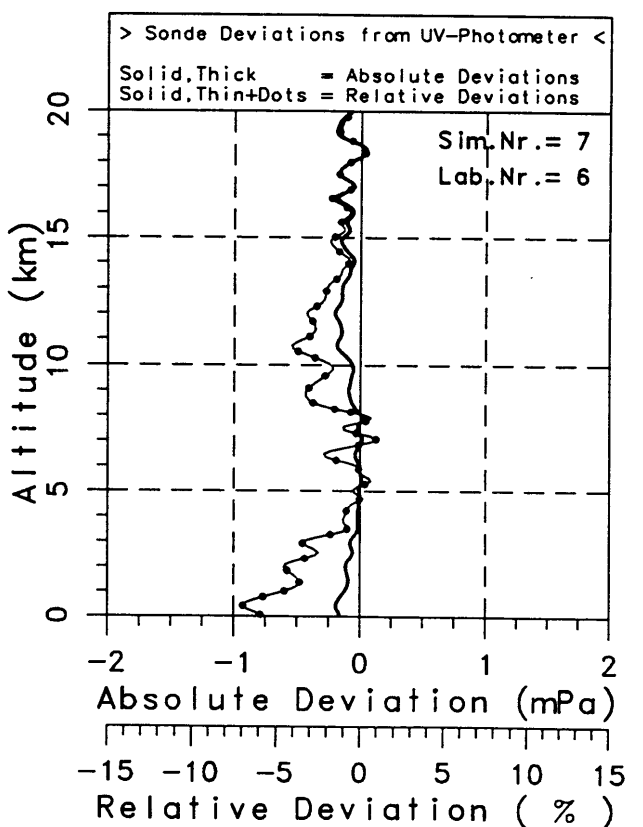
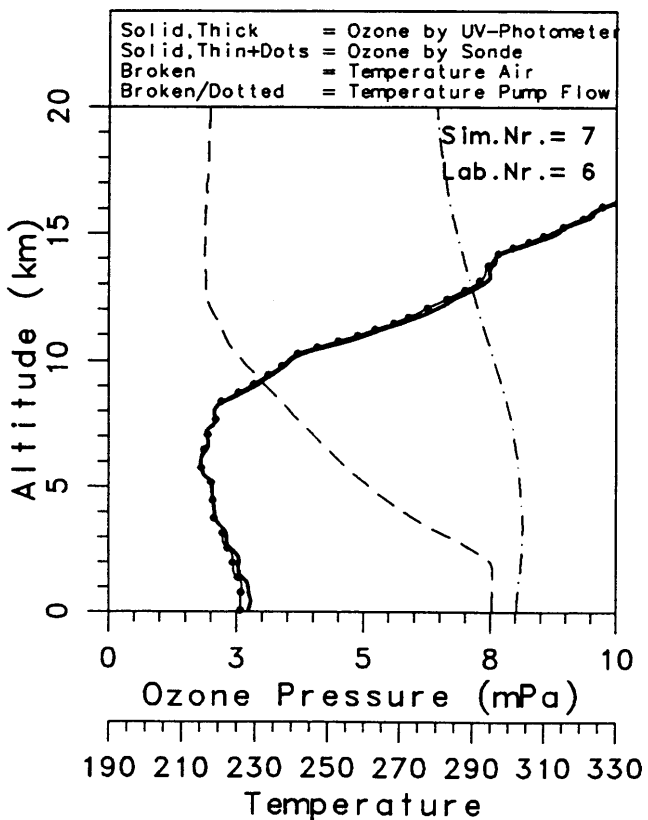
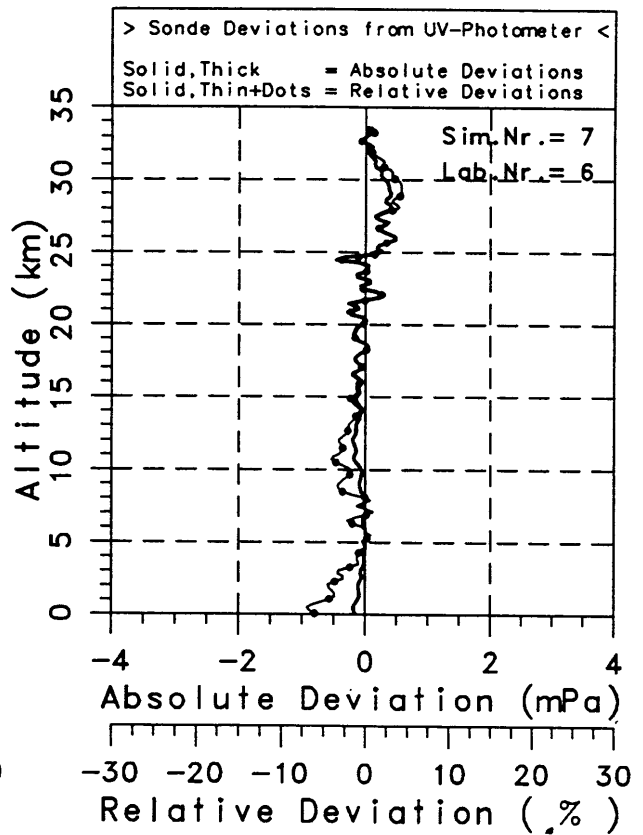
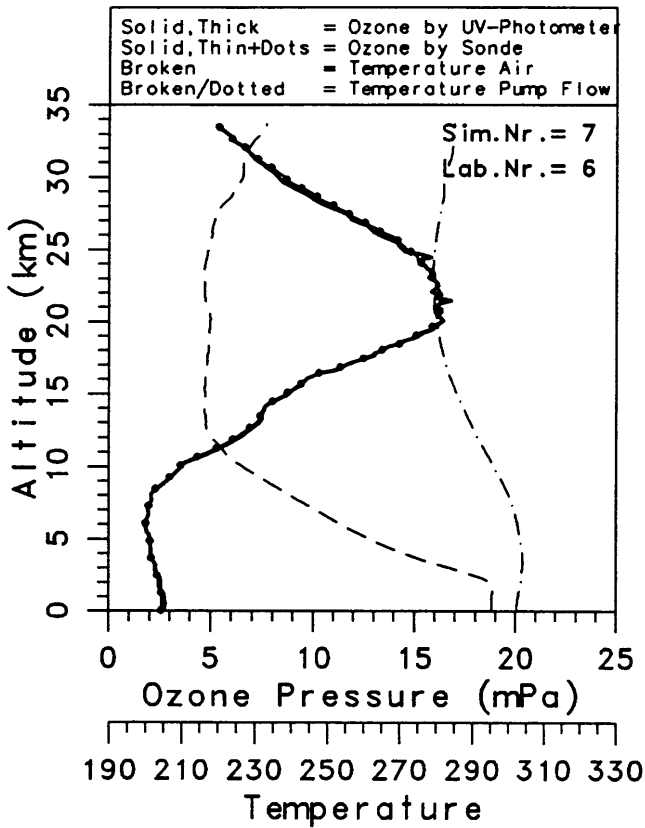

Sim. Exp. Nr. = 7 Date = 28 February 1996 Type Profile = Mid Latitude
 Part. Lab. (7) = CNRS Sonde = ECC/SPC-5A

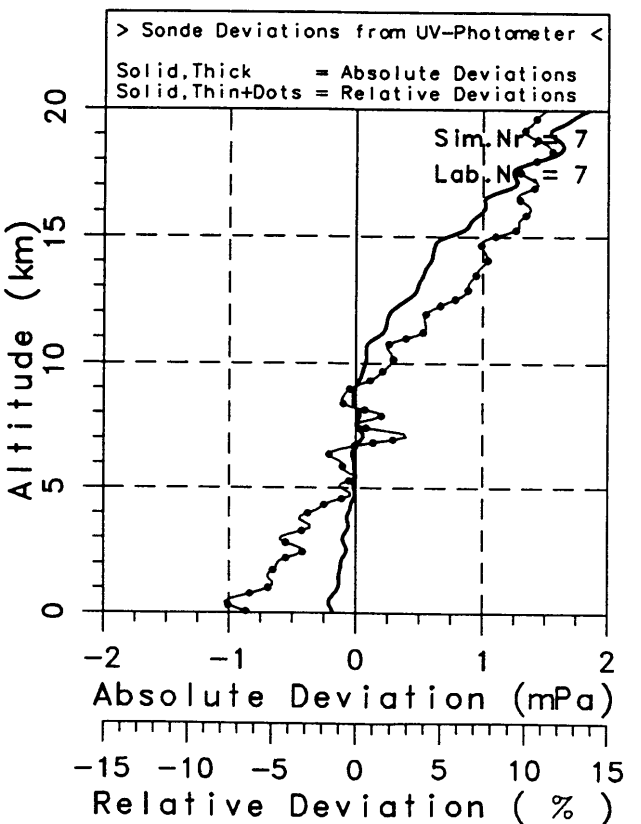
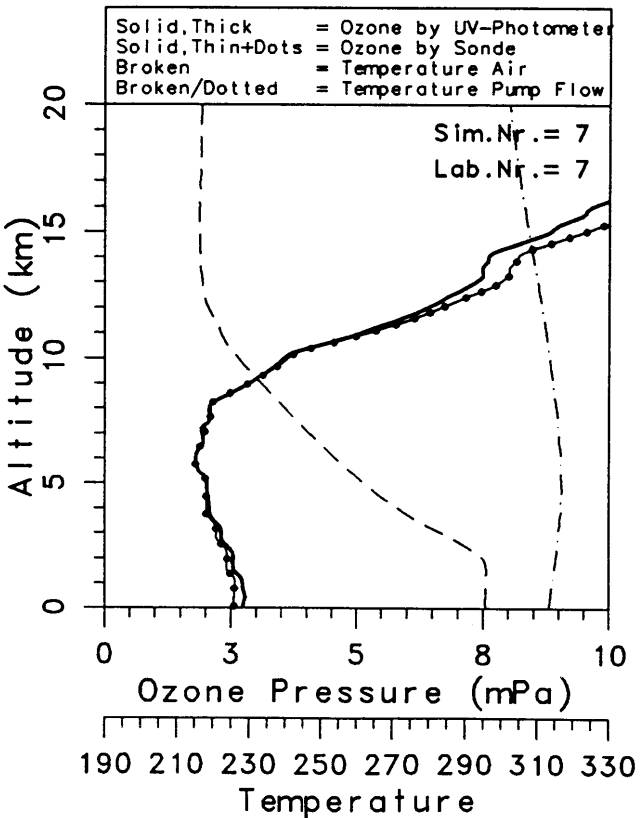
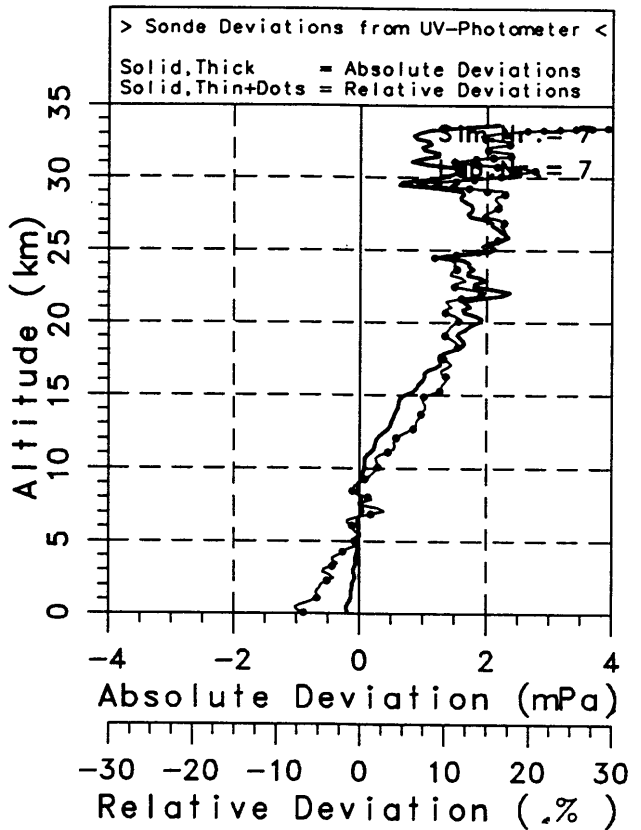
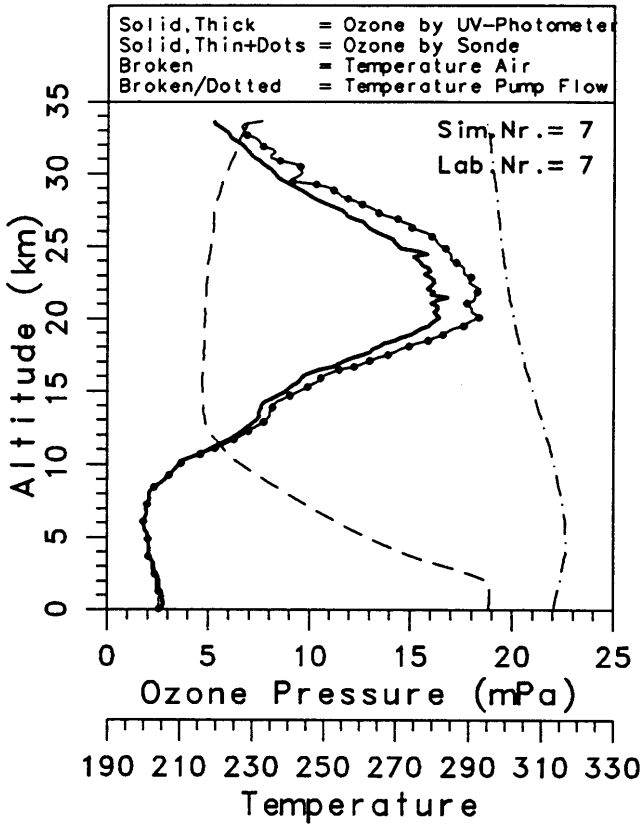

Sim. Exp. Nr. = 7 Date = 28 February 1996 Type Profile = Mid Latitude

Part. Lab. (8) = JMA

Sonde = KC79/JMA

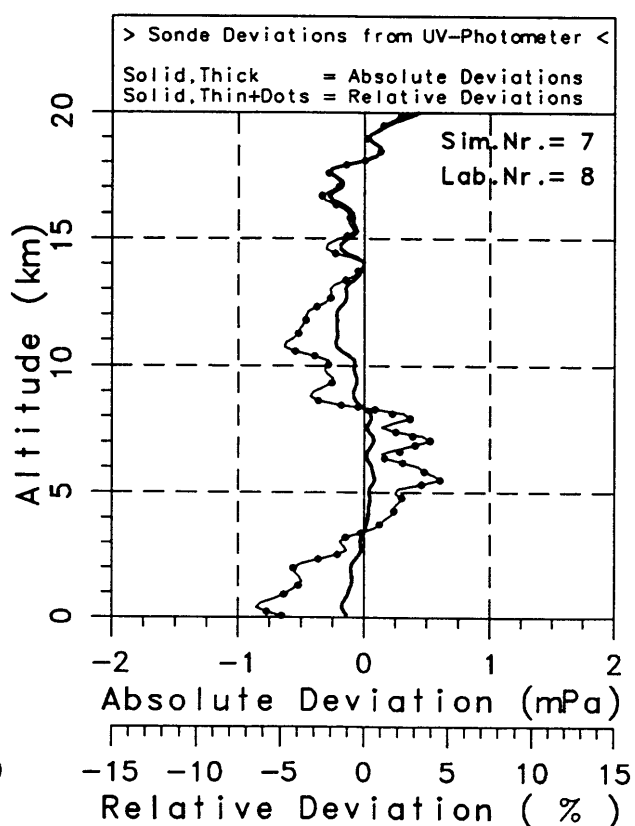
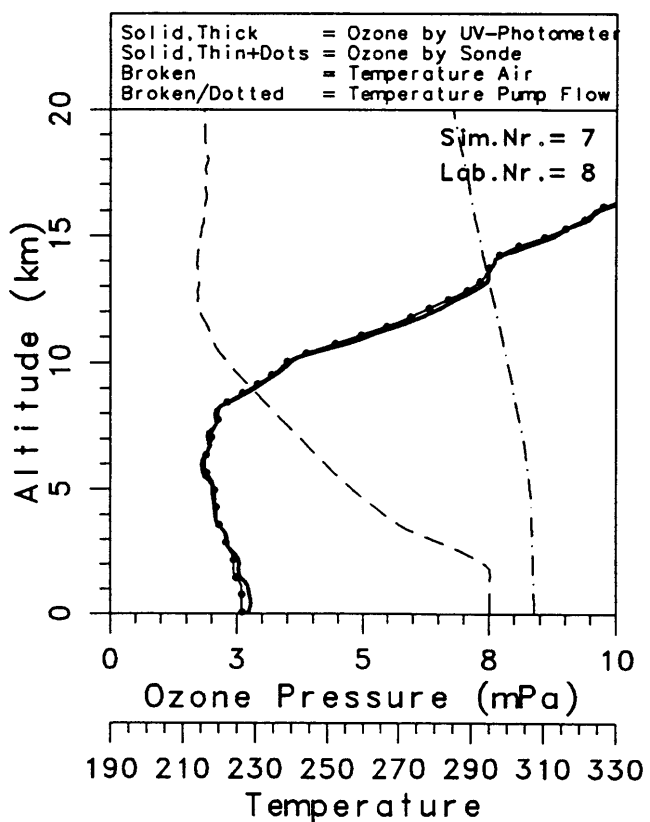
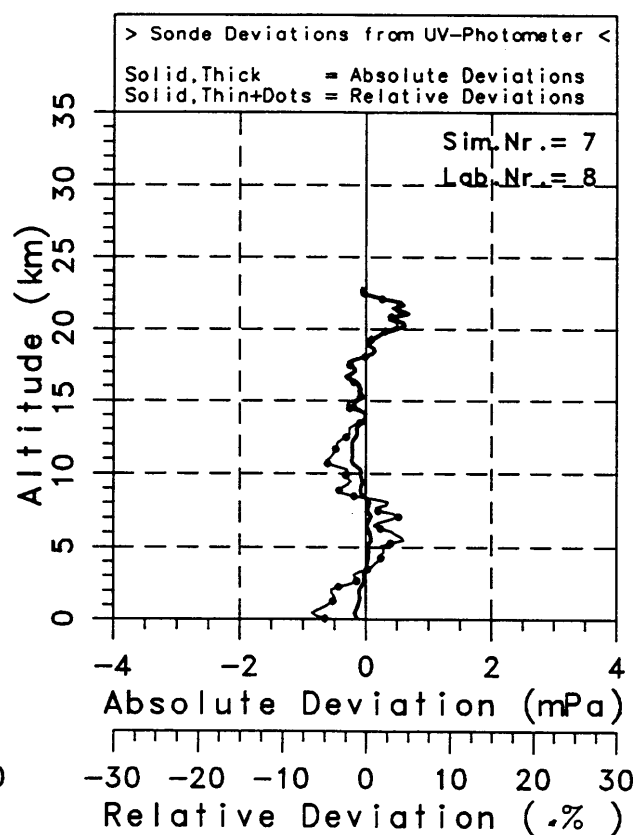
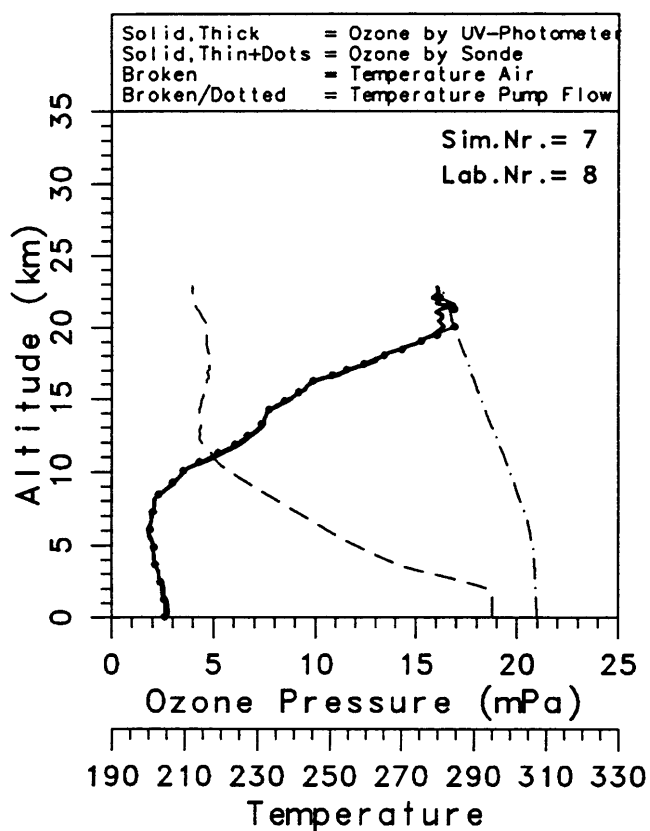

Sim.Exp.Nr. = 8 Date = 29 February 1996 Type Profile = Mid Latitude
 Part.Lab.(5) = ASP Sonde = BM/ECC-Hybrid

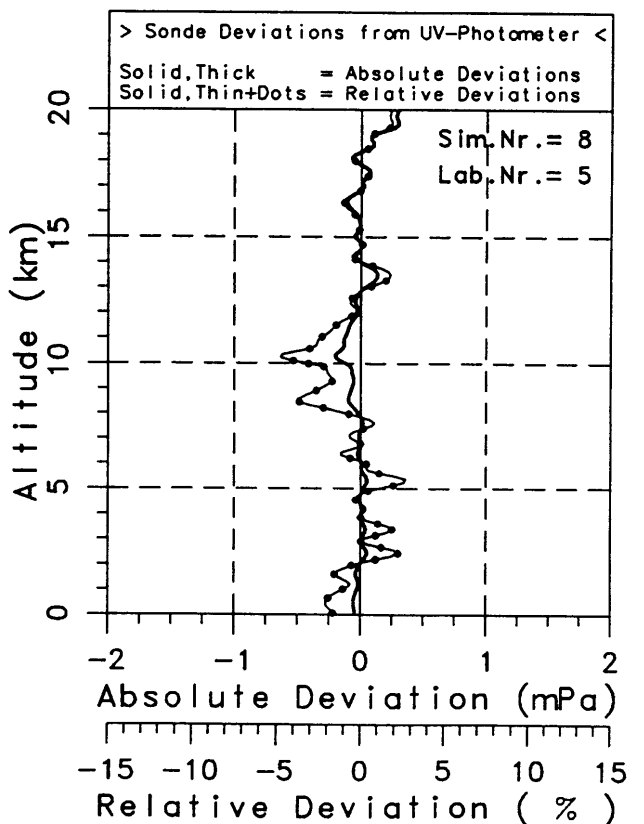
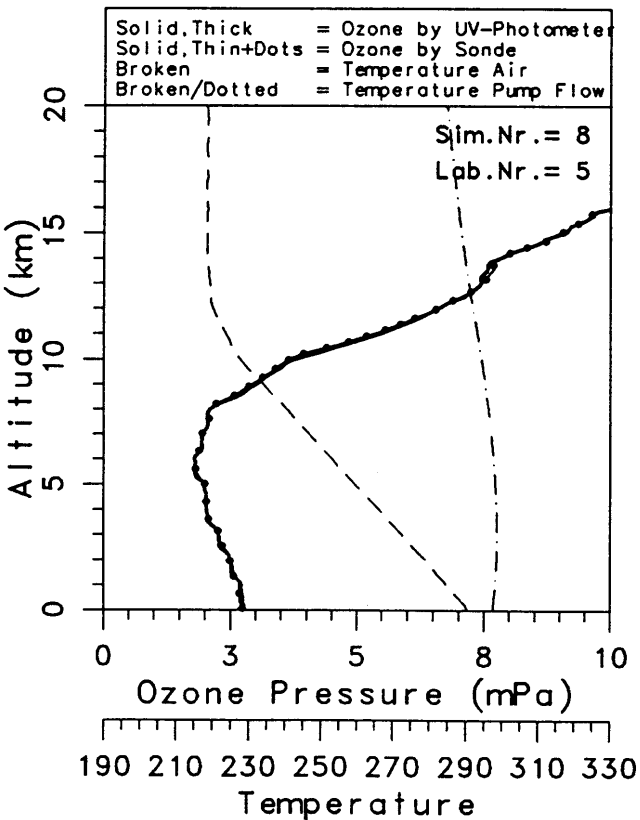
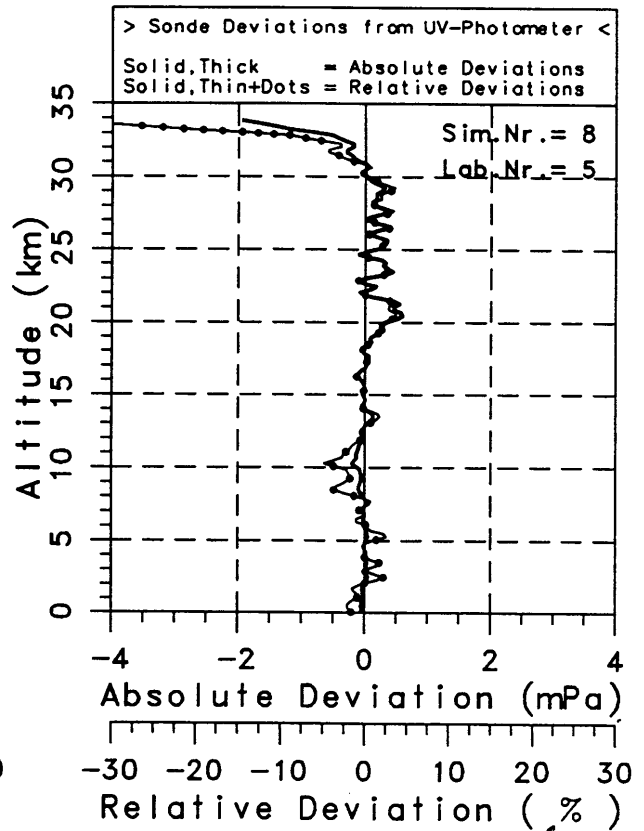
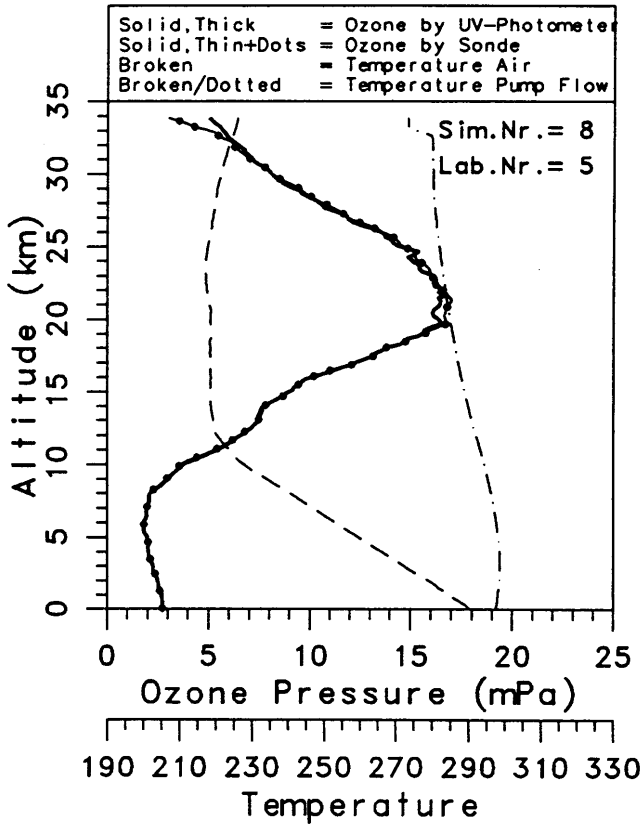

Sim.Exp.Nr. = 8 Date = 29 February 1996 Type Profile = Mid Latitude
 Part.Lab.(6) = AES Sonde = ECC/SPC-5A

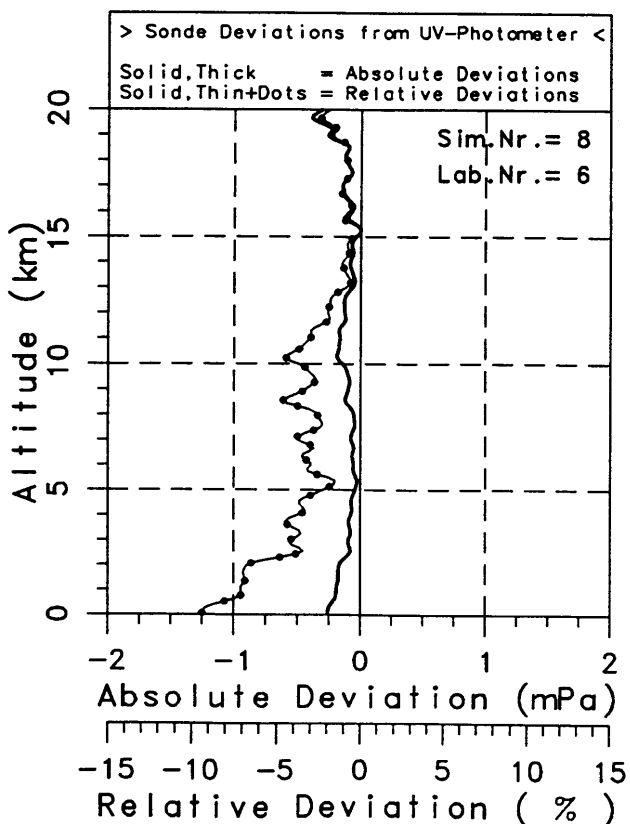
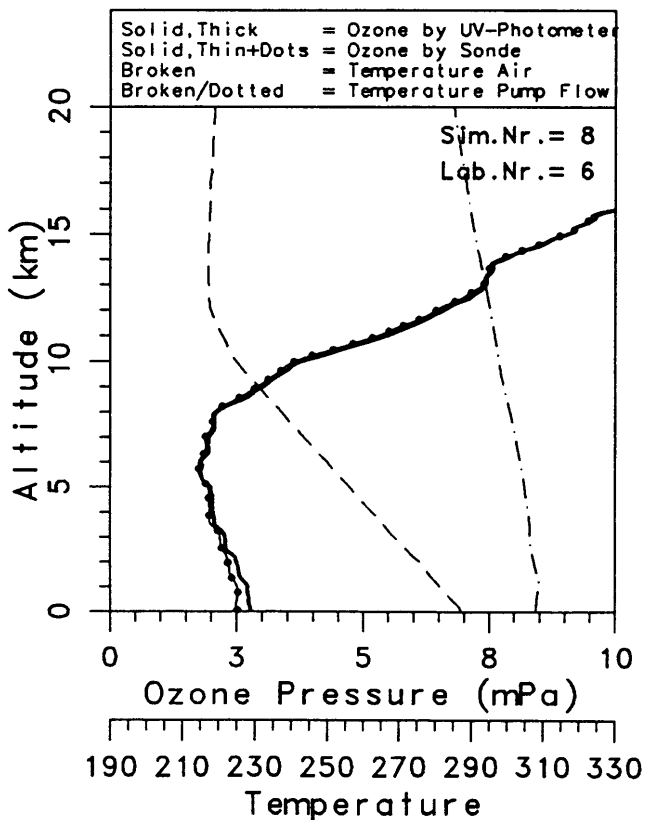
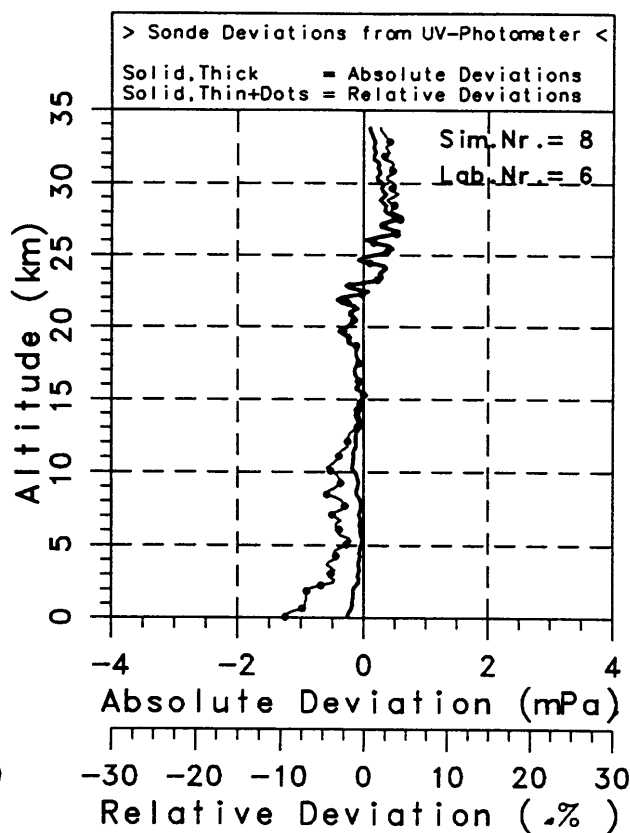
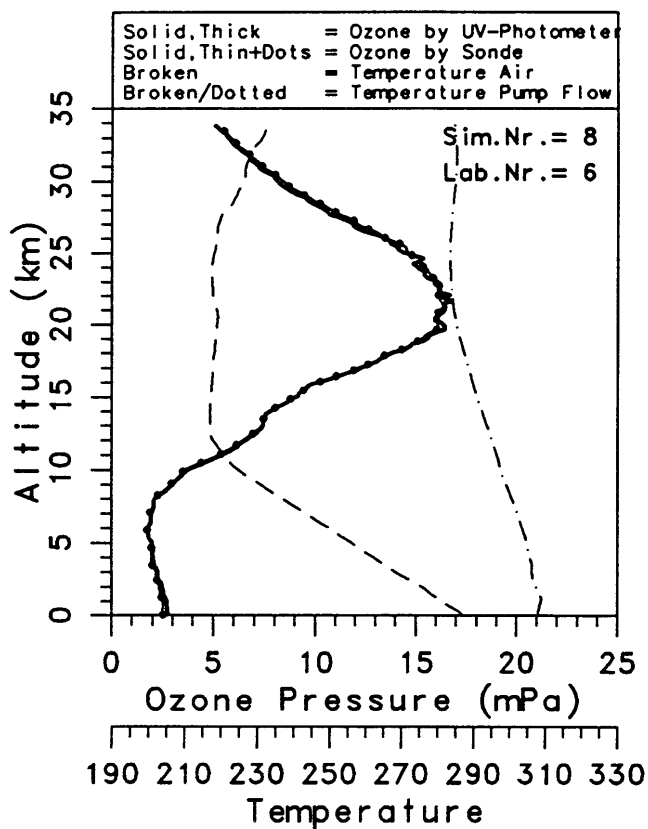

Sim.Exp.Nr. = 8 Date = 29 February 1996 Type Profile = Mid Latitude
 Part.Lab.(7) = CNRS Sonde = ECC/SPC-5A

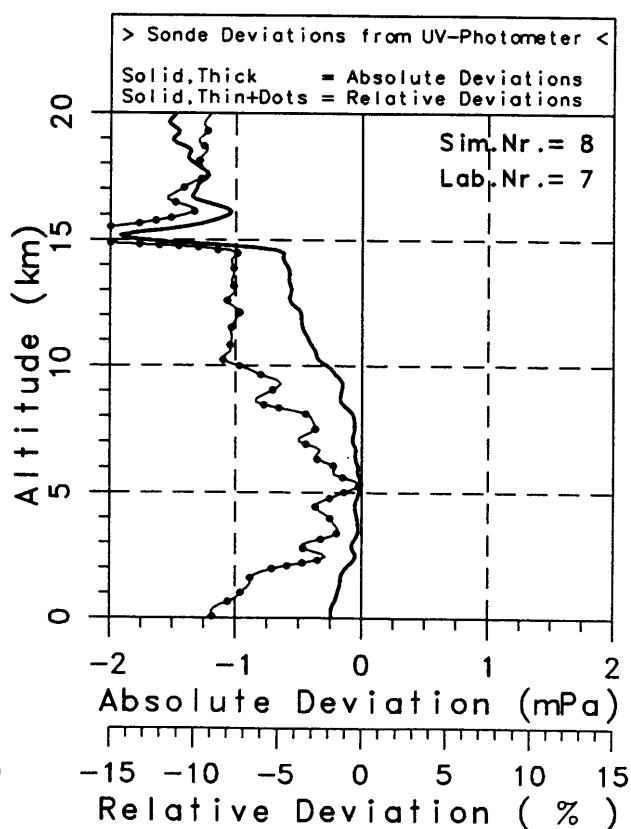
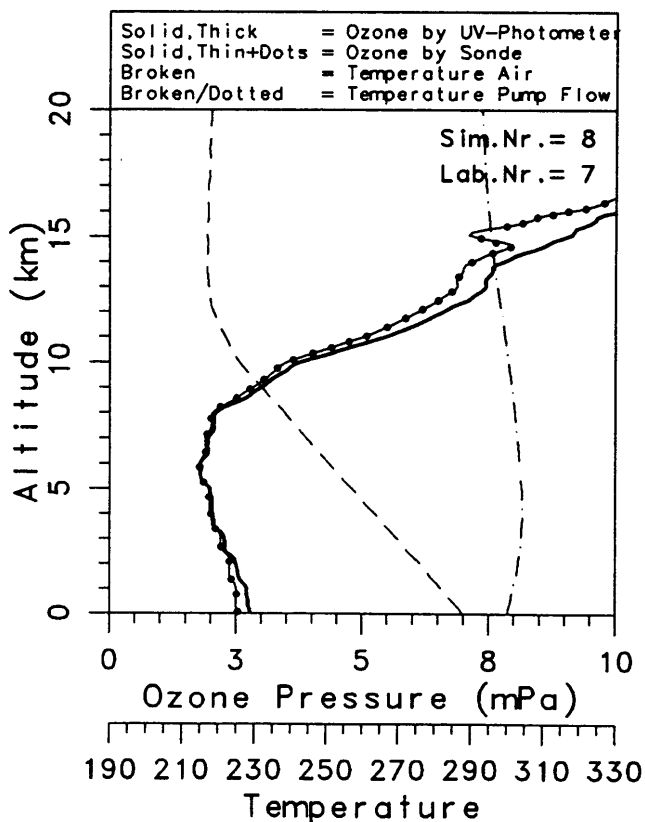
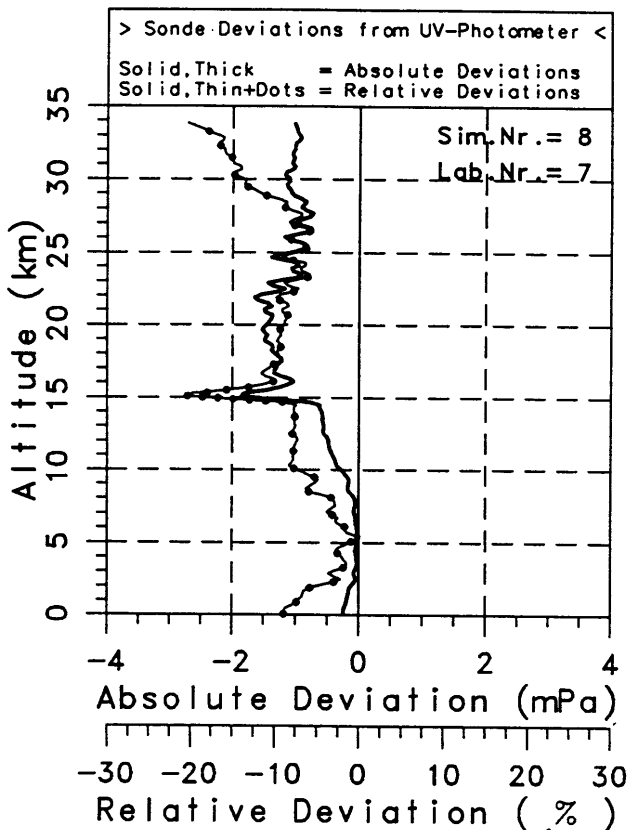
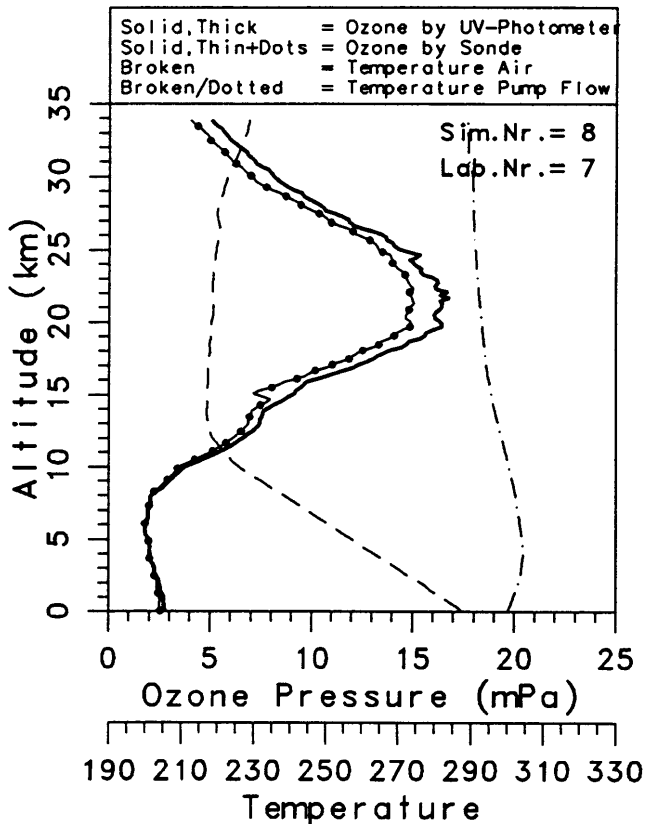

Sim. Exp. Nr. = 8 Date = 29 February 1996 Type Profile = Mid Latitude
 Part. Lab. (8) = JMA Sonde = KC79/JMA

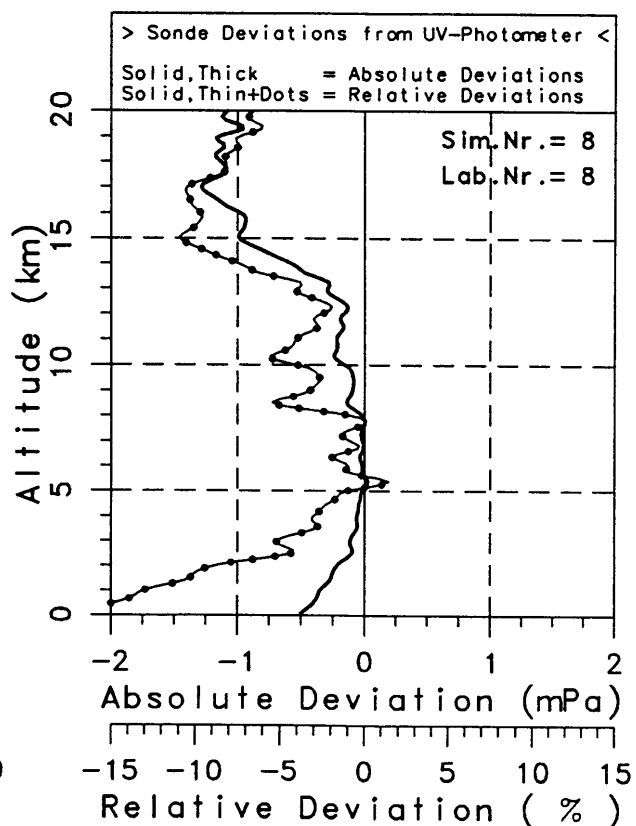
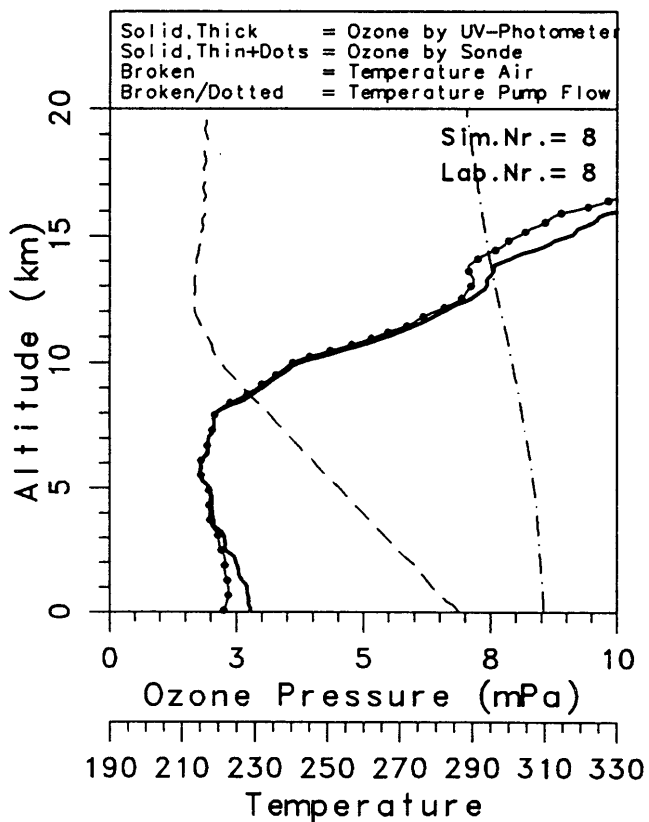
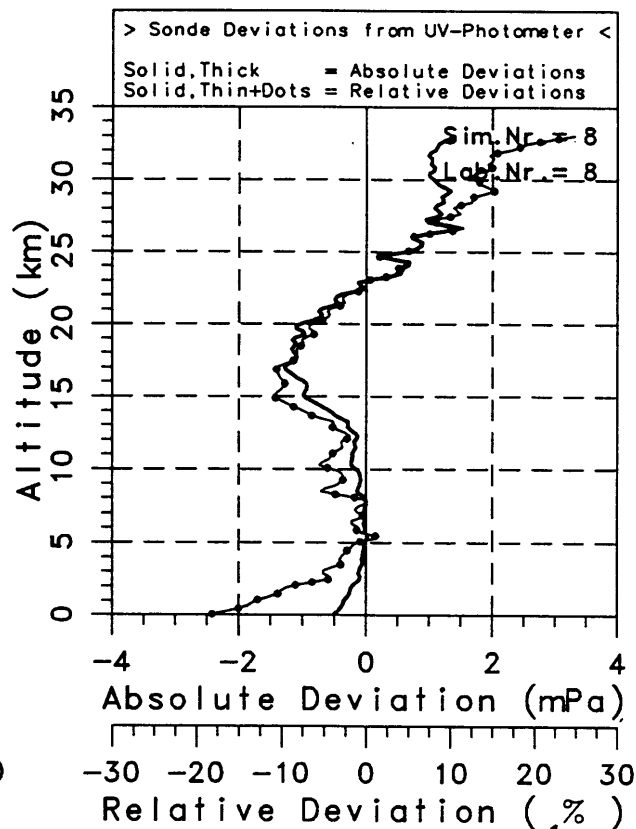
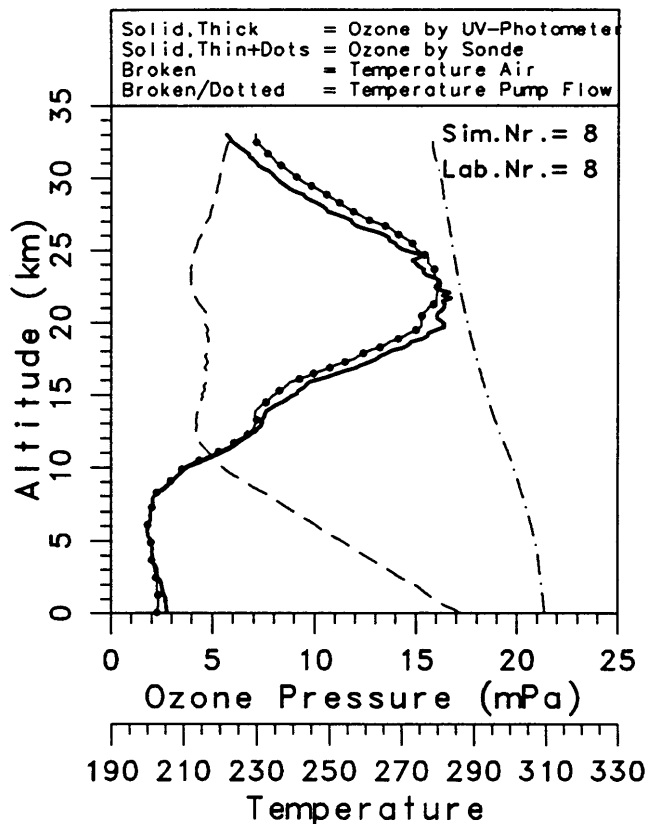

Sim.Exp.Nr. = 9 Date = 01 March 1996

Type Profile = Mid Latitude

Part.Lab.(5) = ASP

Sonde = BM/ECC-Hybrid

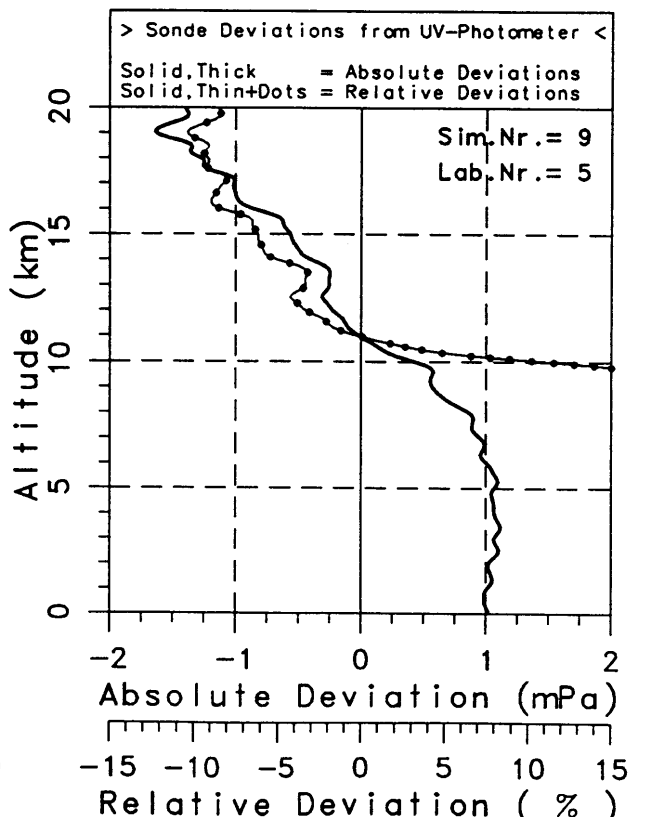
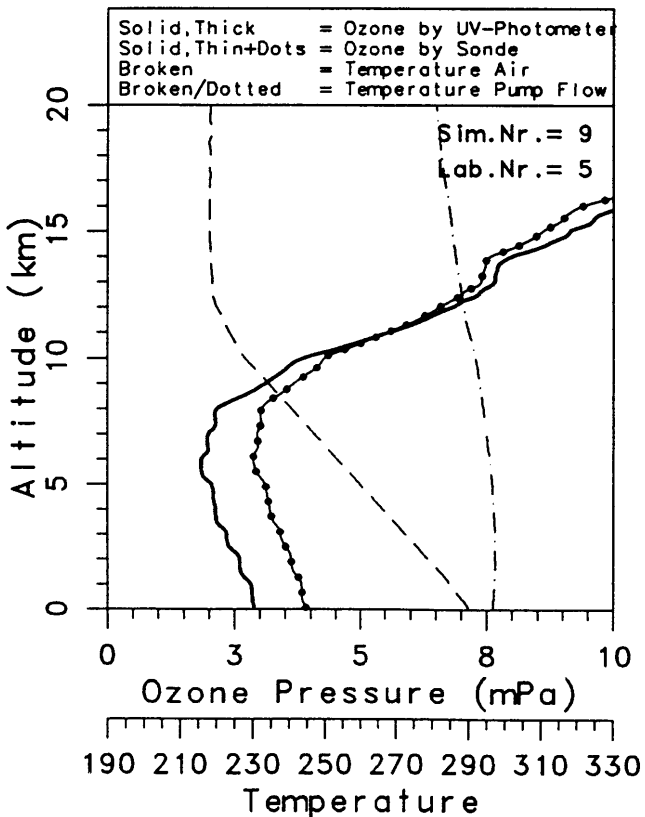
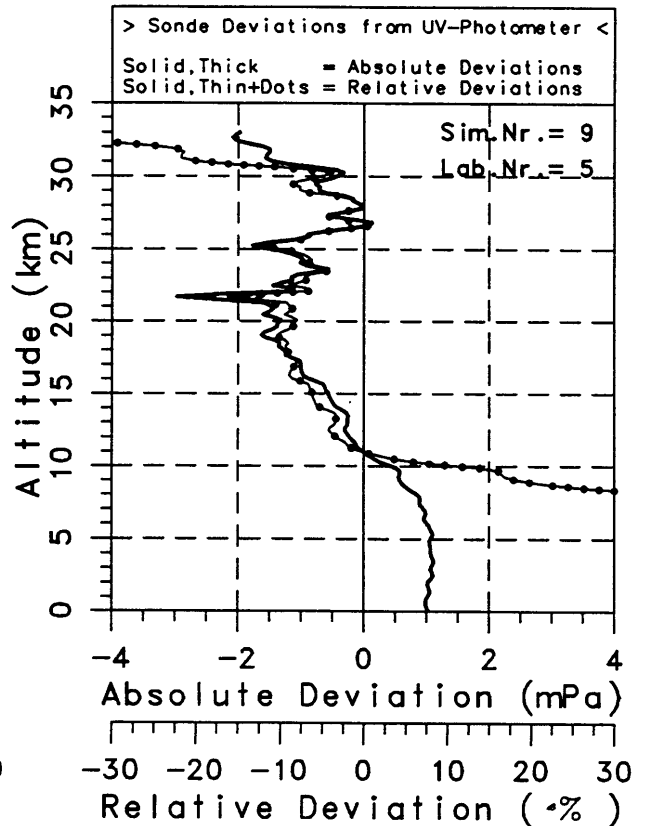
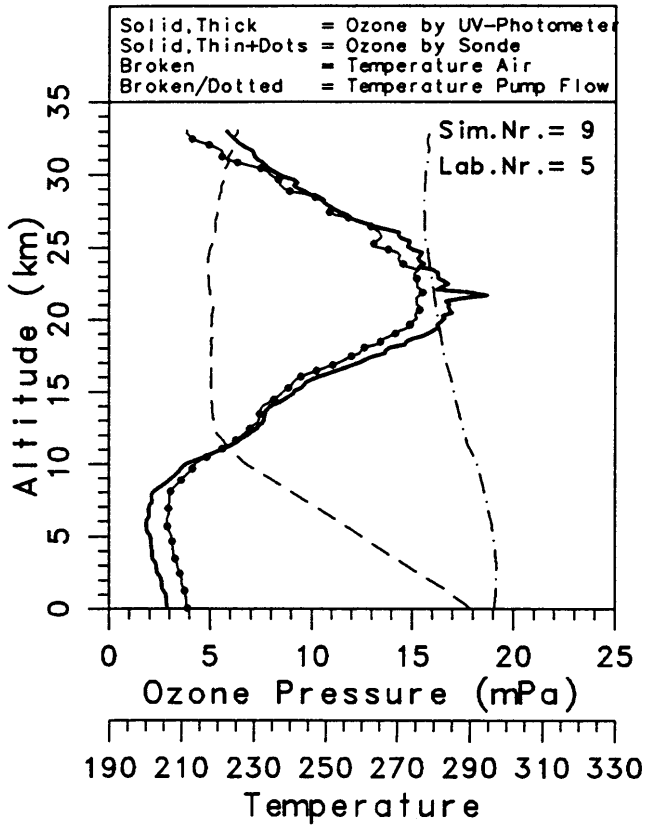

Sim.Exp.Nr. = 9 Date = 01 March 1996

Type Profile = Mid Latitude

Part.Lab.(6) = AES

Sonde = ECC/SPC-5A

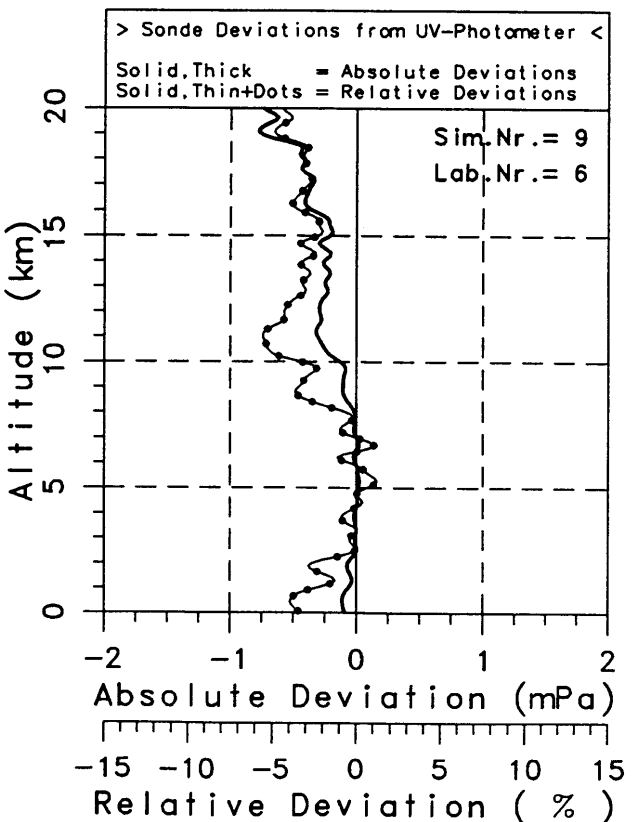
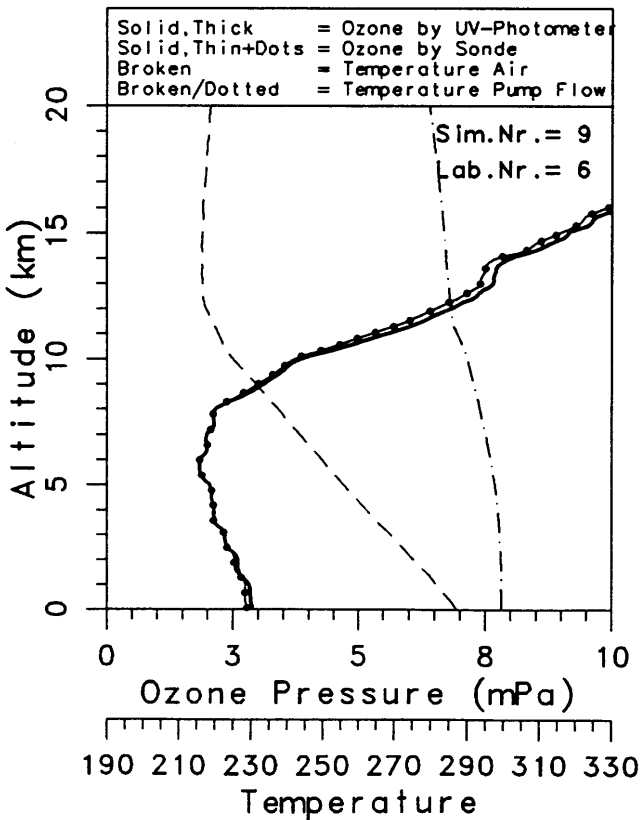
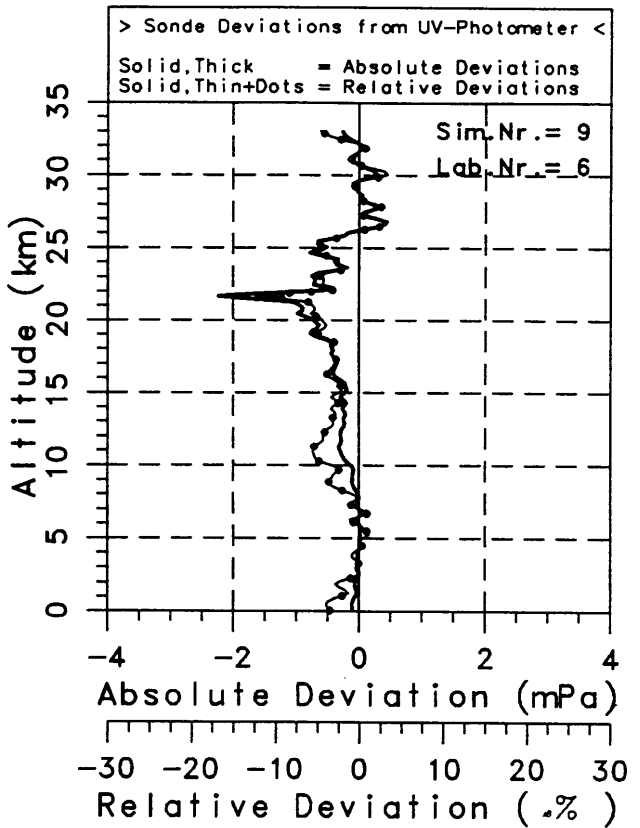
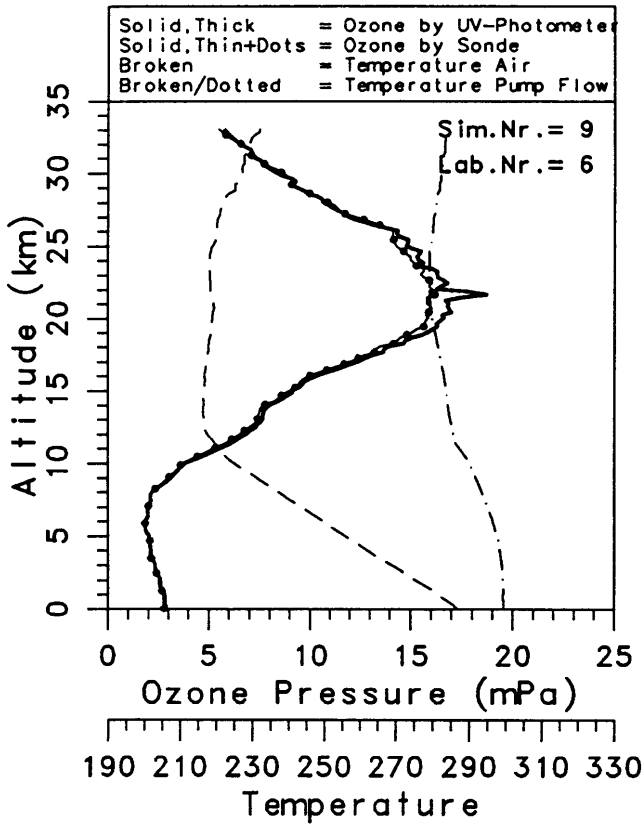

Sim.Exp.Nr. = 9 Date = 01 March 1996

Type Profile = Mid Latitude

Part.Lab.(7) = CNRS

Sonde = ECC/SPC-5A

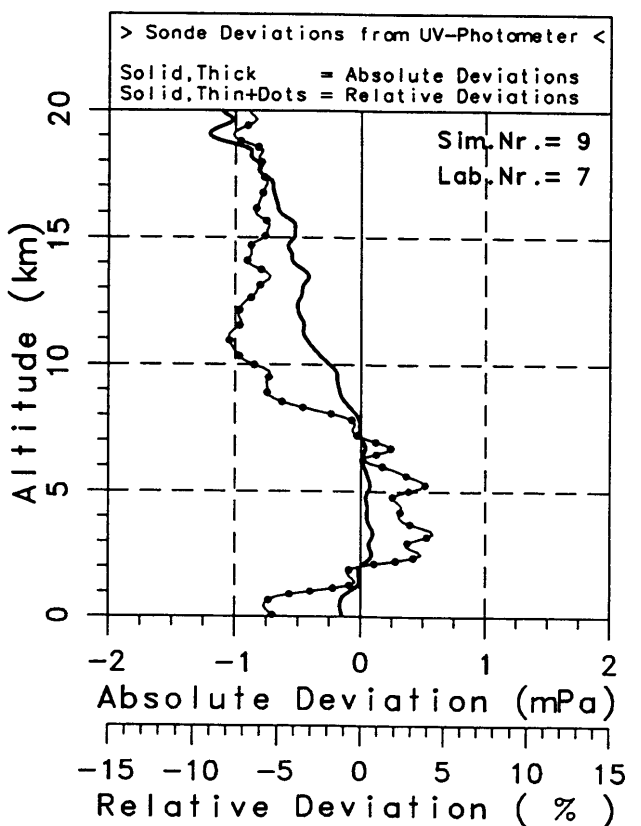
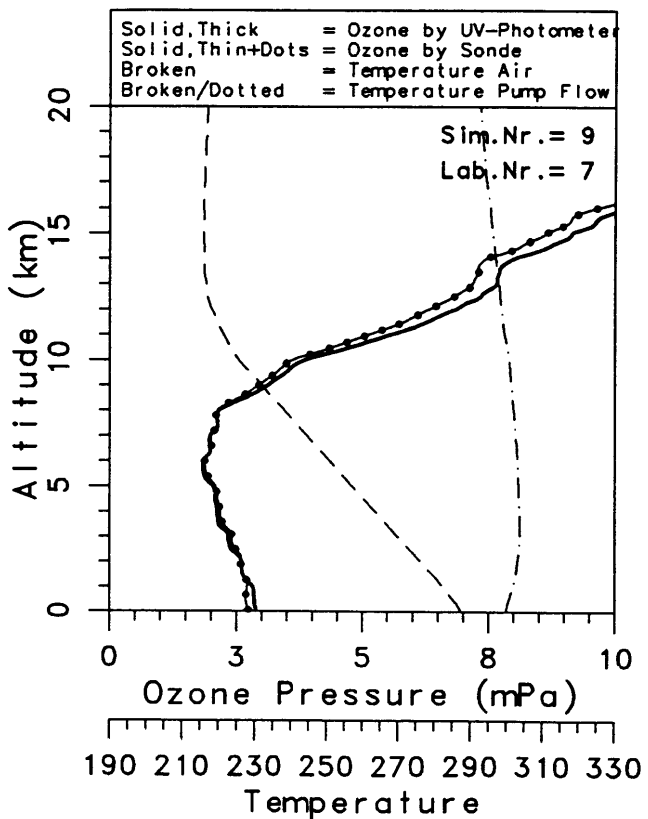
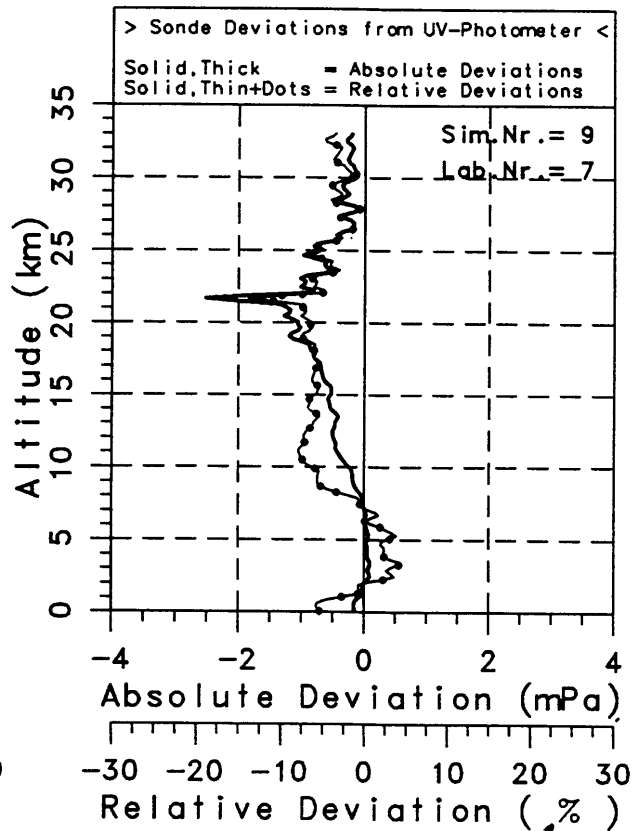
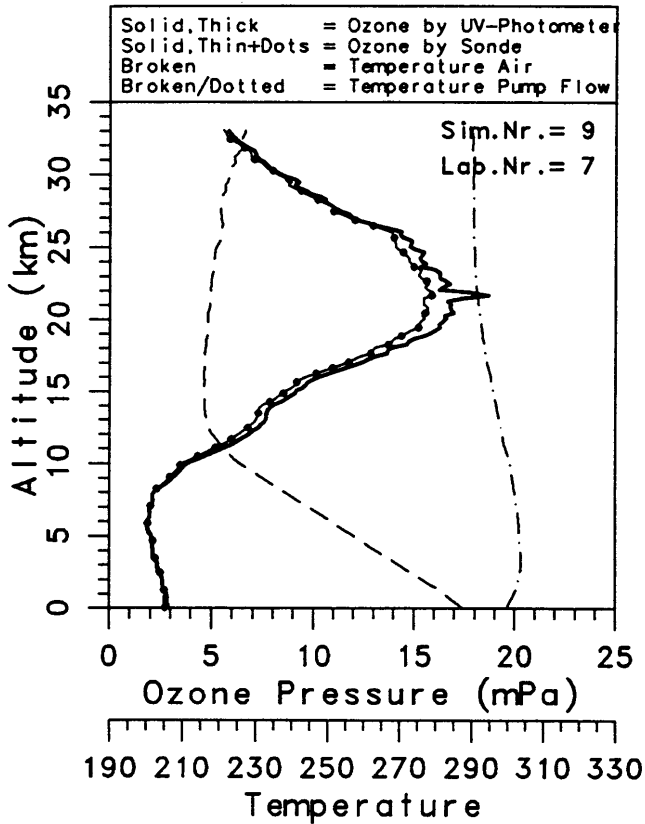

Sim.Exp.Nr. = 9 Date = 01 March 1996

Type Profile = Mid Latitude

Part.Lab.(8) = JMA

Sonde = KC79/JMA

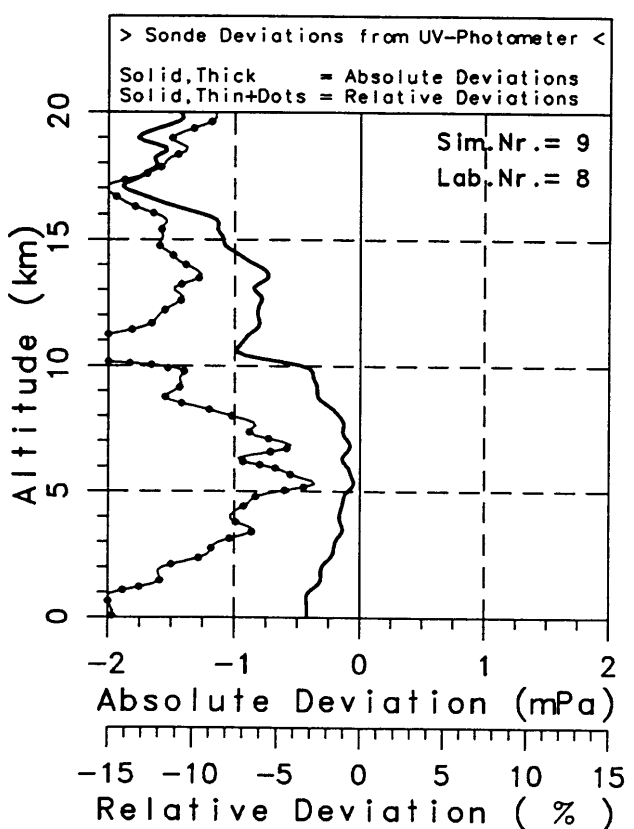
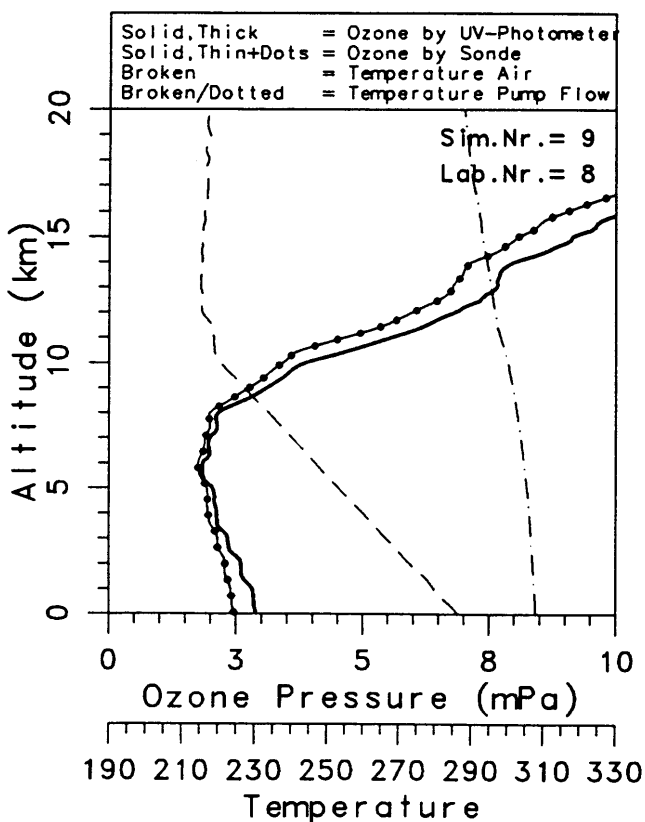
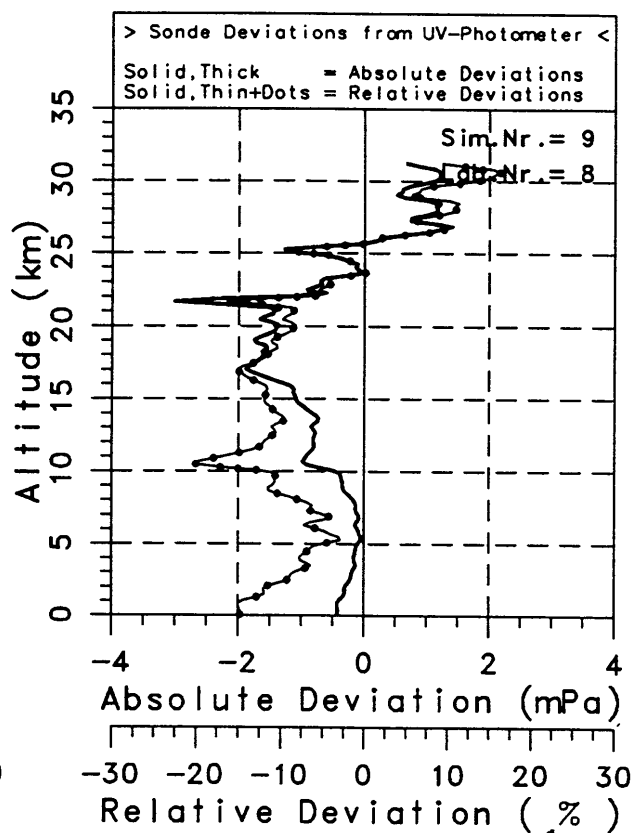
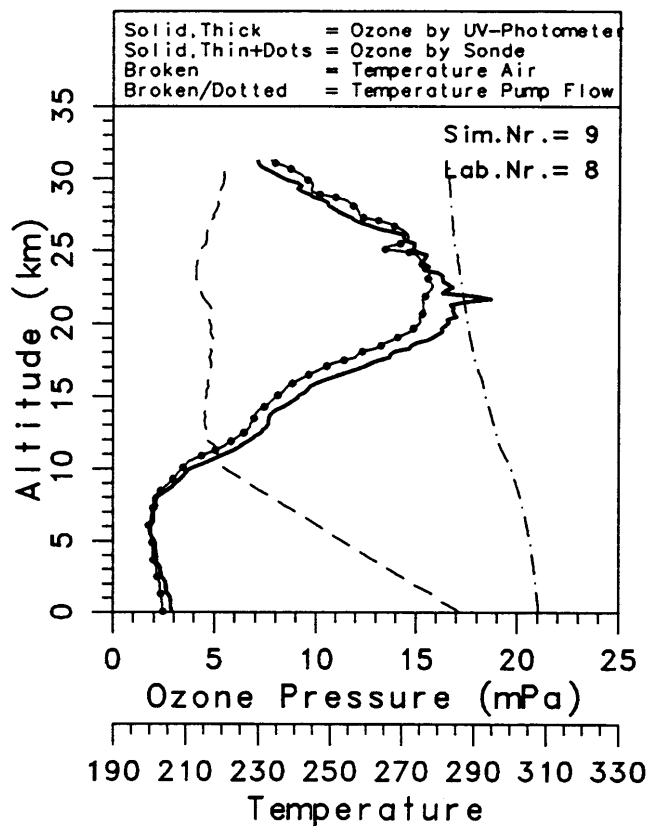

Sim.Exp.Nr. =10 Date = 04 March 1996

Type Profile = Tropics

Part.Lab.(5) = ASP

Sonde = BM/ECC-Hybrid

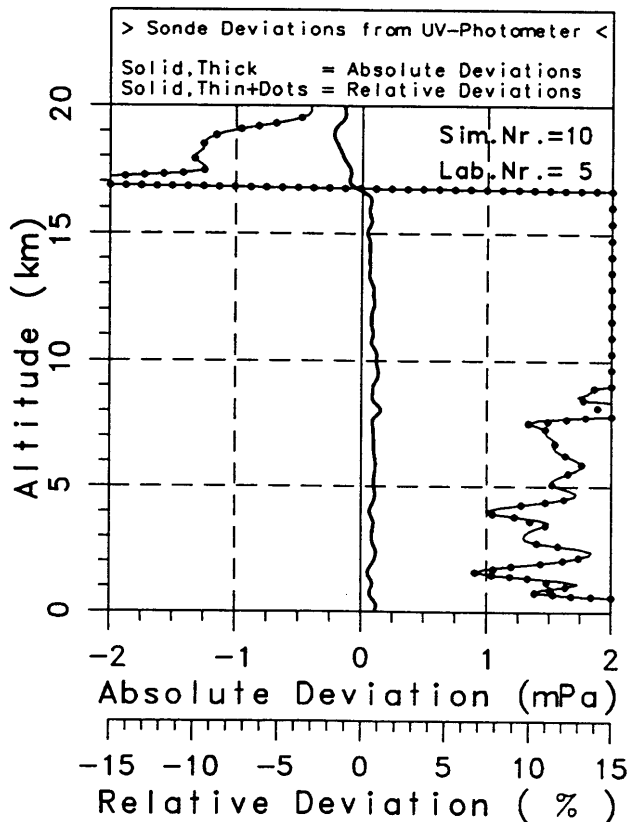
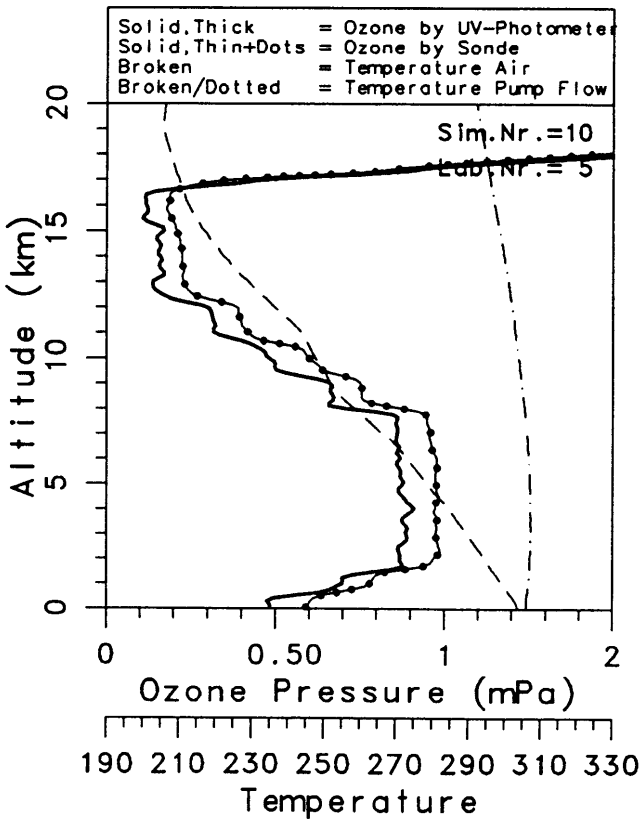
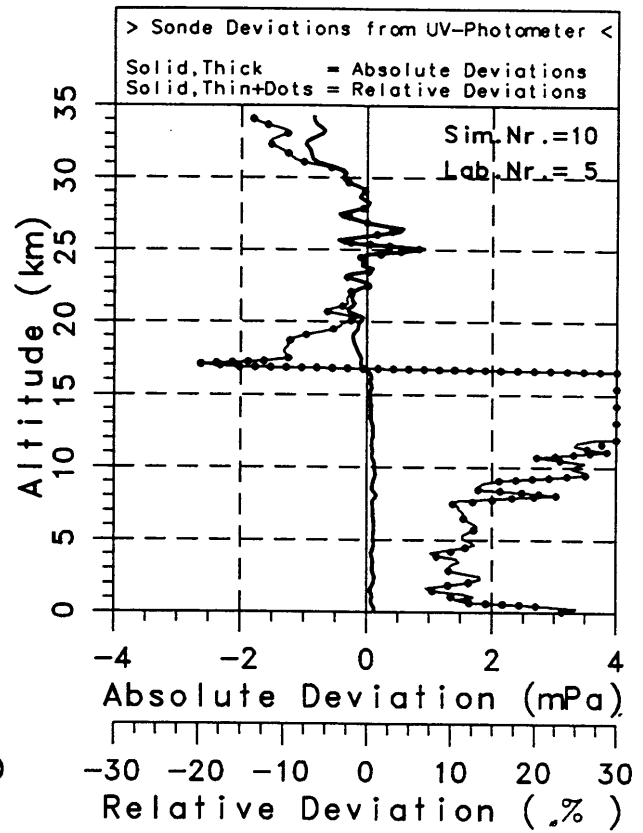
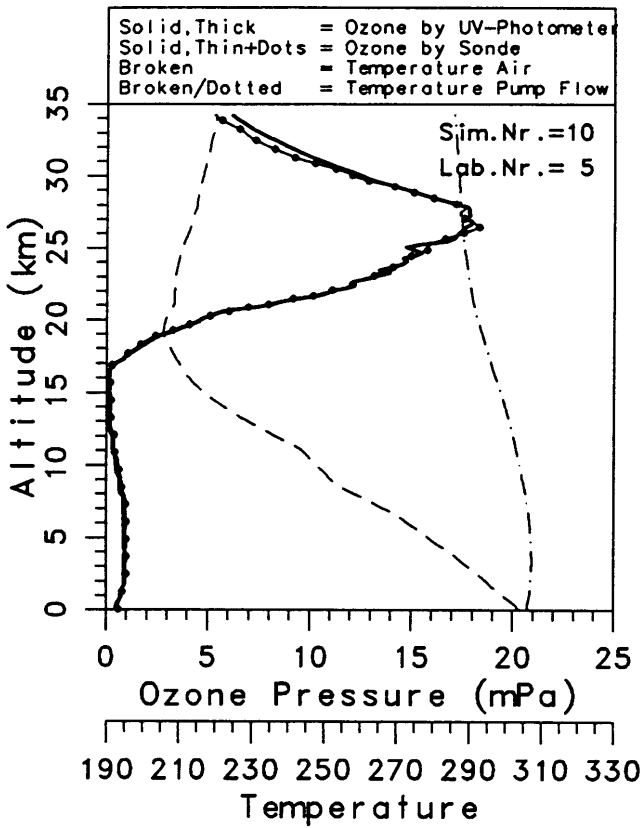

Sim.Exp.Nr. =10 Date = 04 March 1996

Type Profile = Tropics

Part.Lab.(6) = AES

Sonde = ECC/ENSCI-1Z

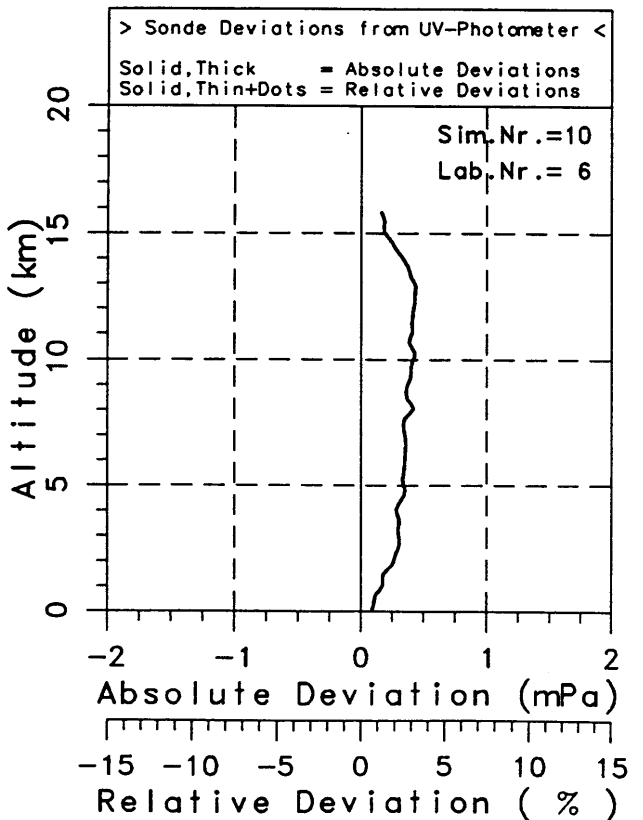
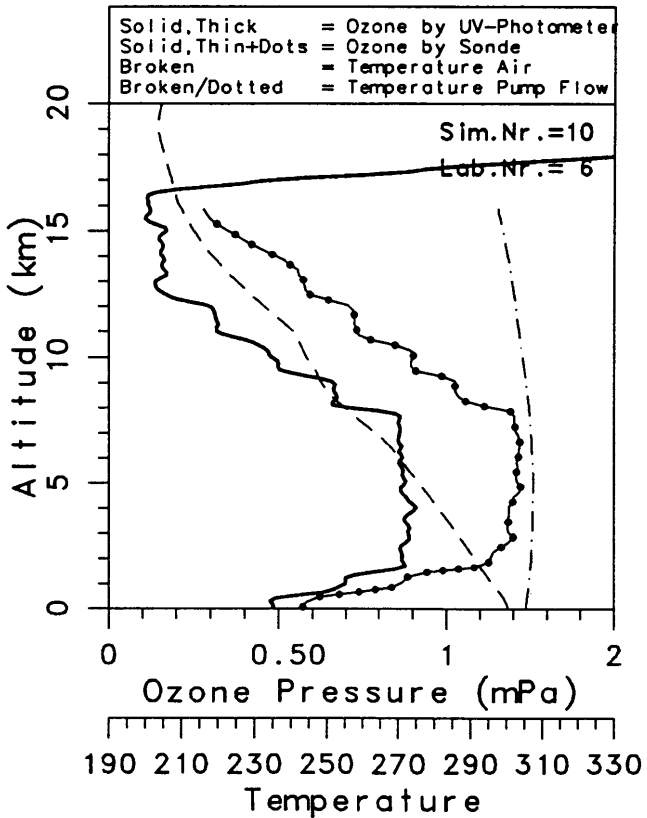
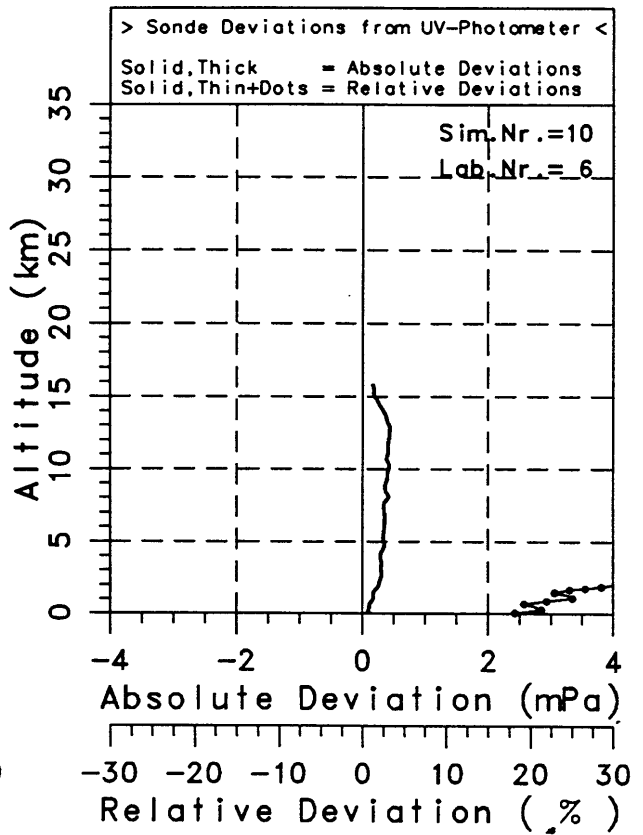
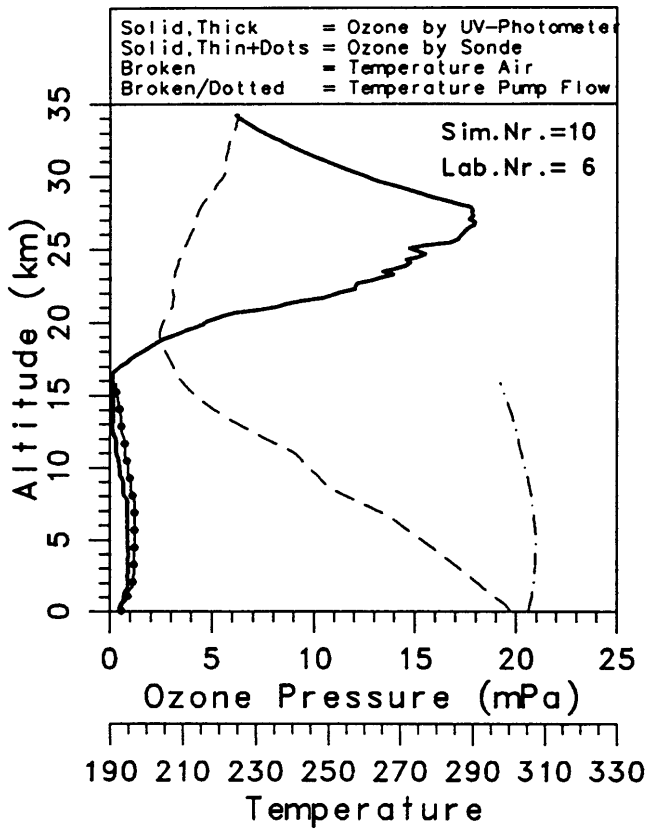

Sim.Exp.Nr. = 10 Date = 04 March 1996

Type Profile = Tropics

Part.Lab.(7) = CNRS

Sonde = ECC/SPC-5A

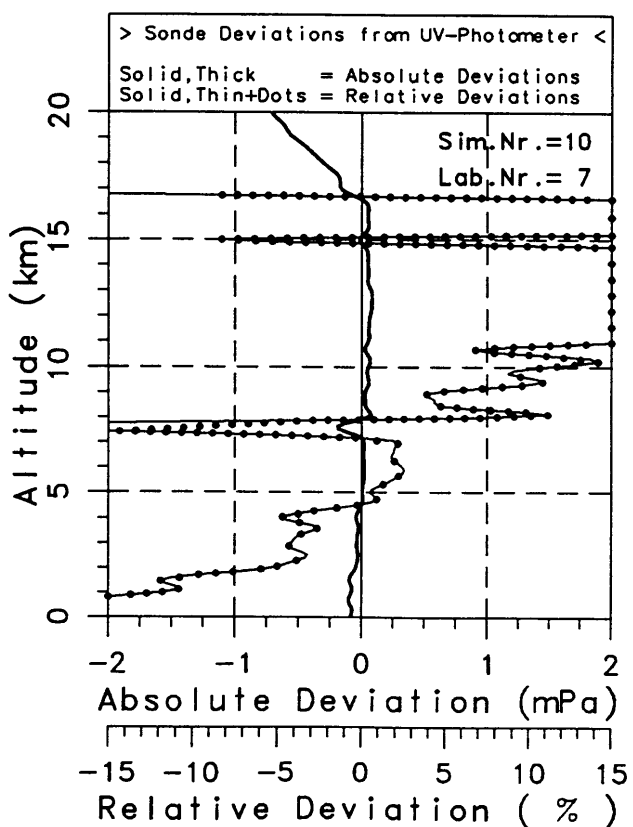
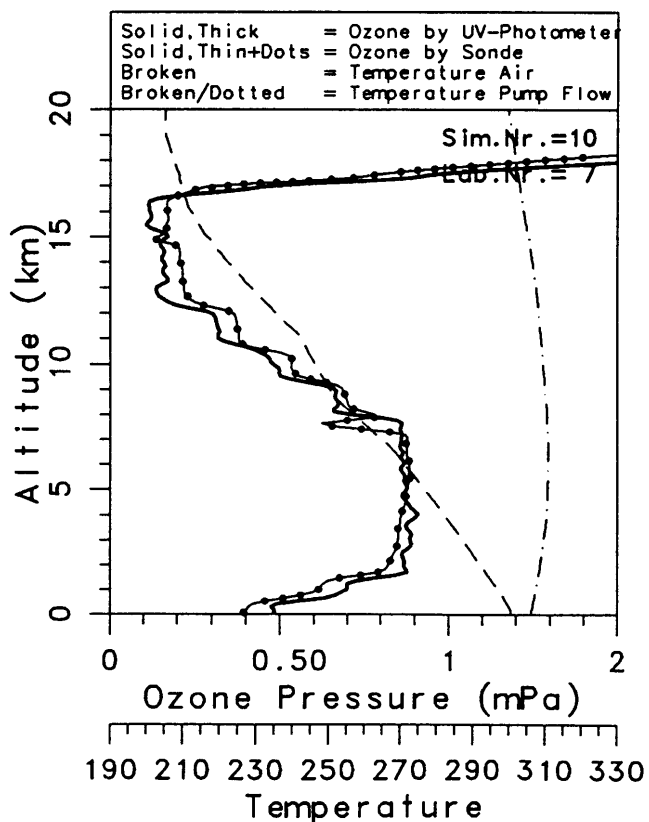
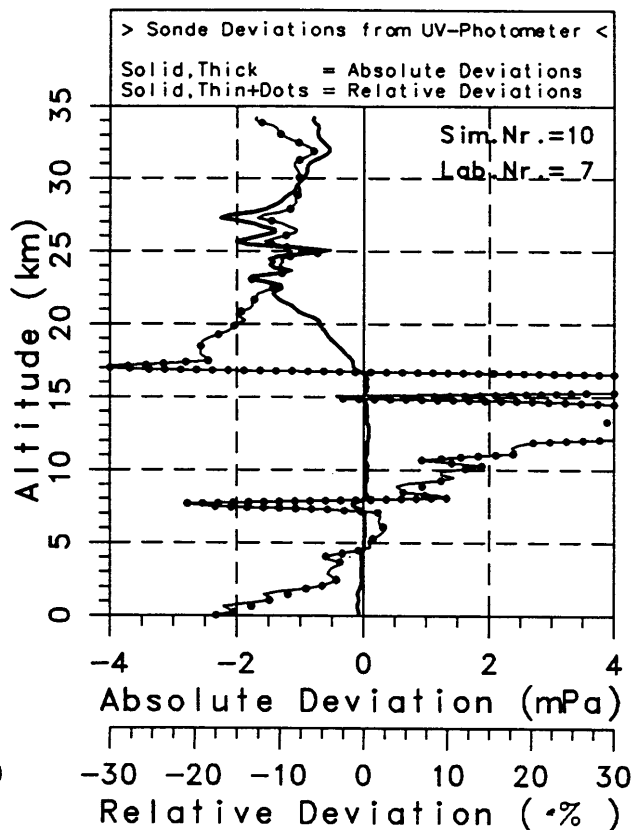
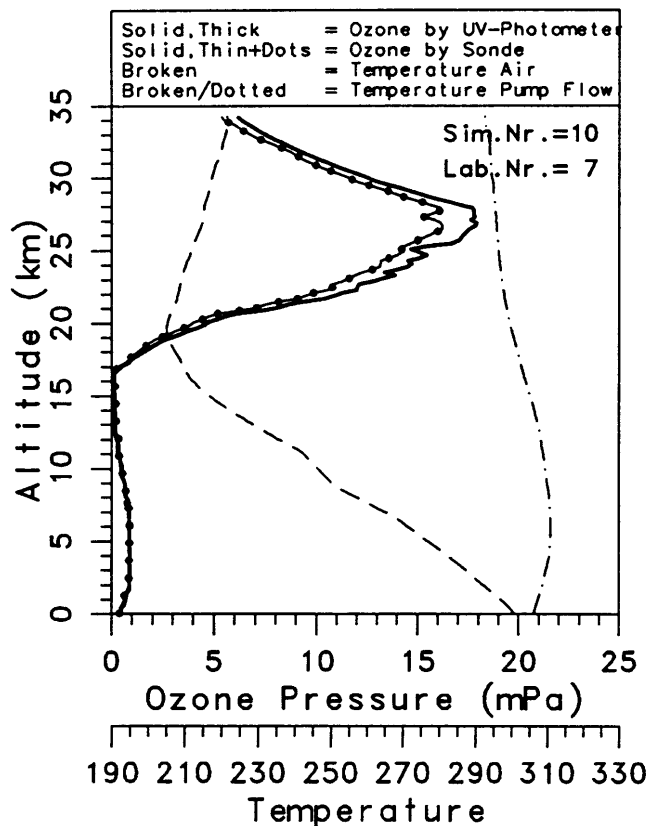

Sim.Exp.Nr. =10 Date = 04 March 1996

Type Profile = Tropics

Part.Lab.(8) = JMA

Sonde = KC79/JMA

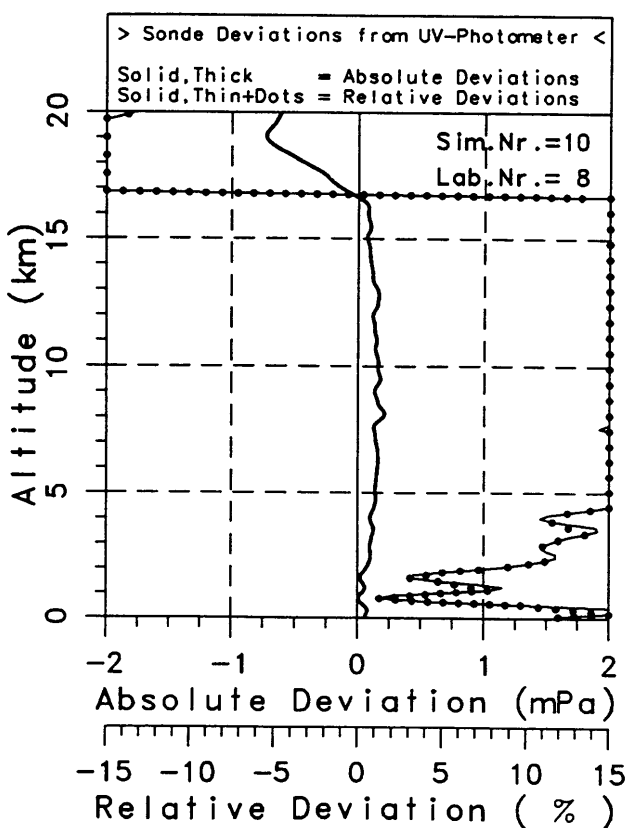
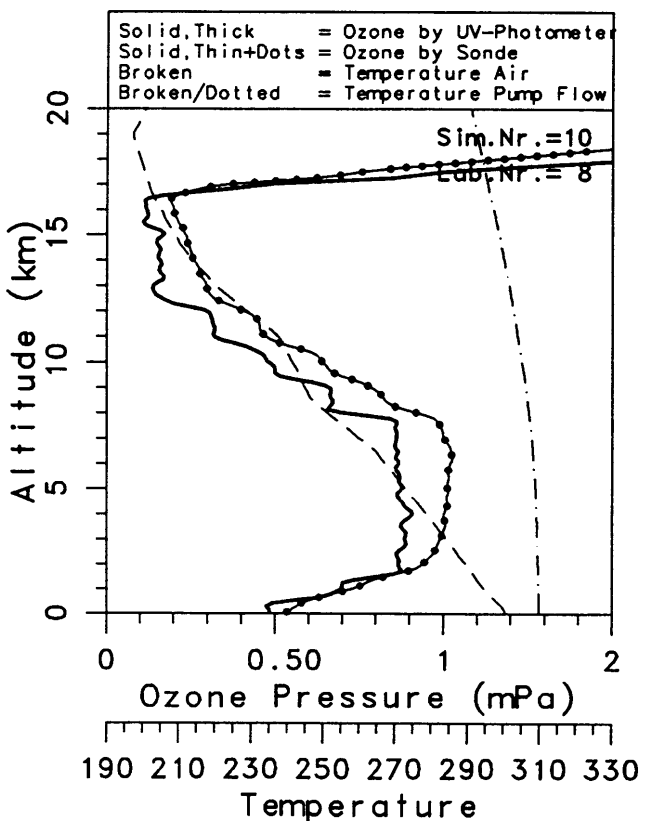
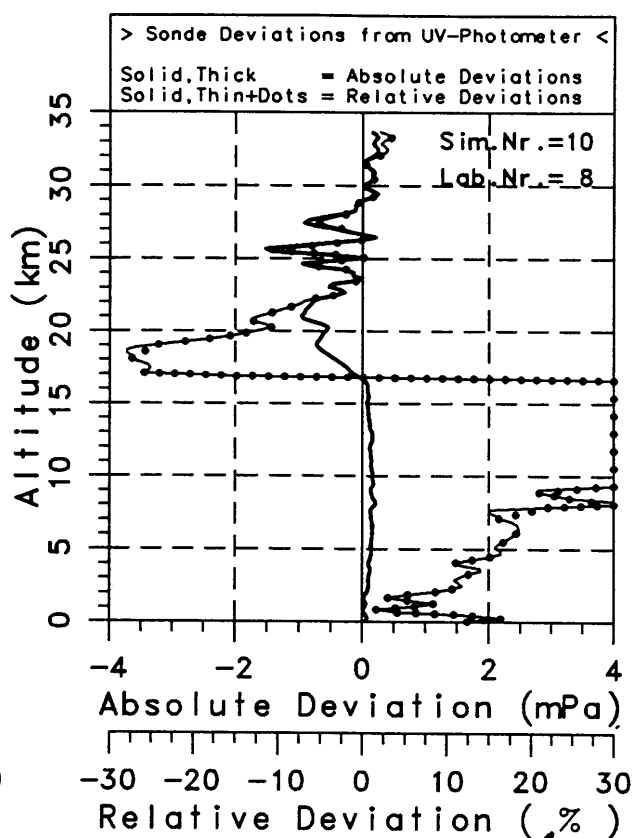
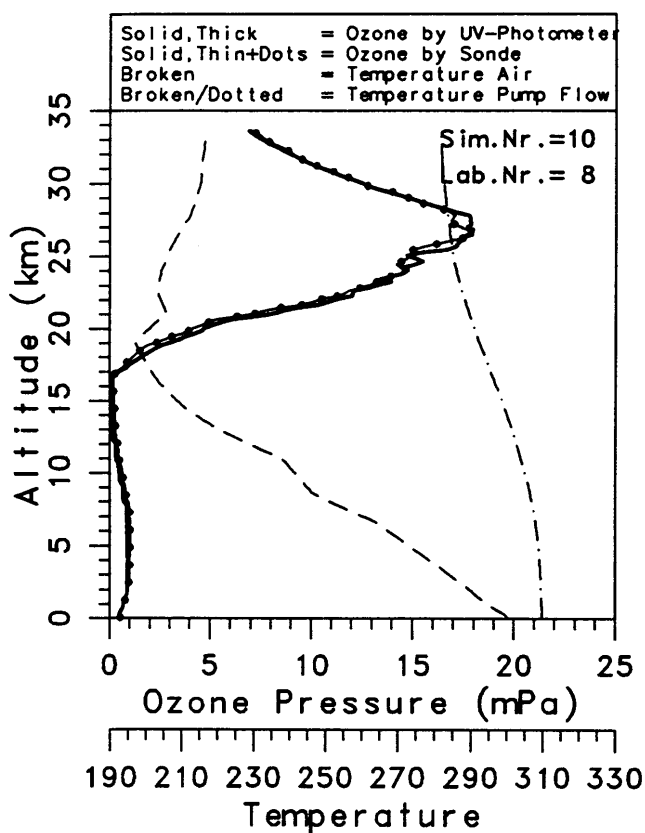

Sim.Exp.Nr. = 11 Date = 05 March 1996

Type Profile = Tropics

Part.Lab.(5) = ASP

Sonde = BM/ECC-Hybrid

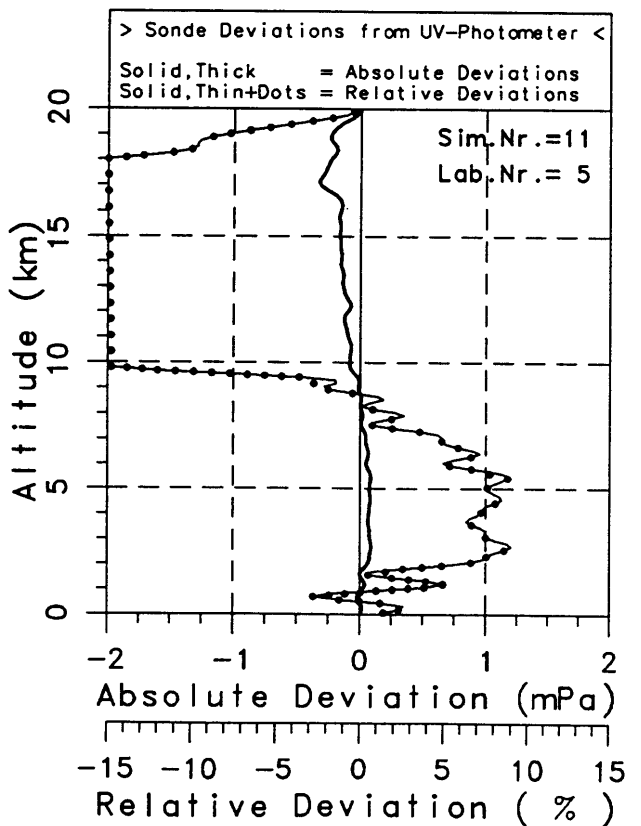
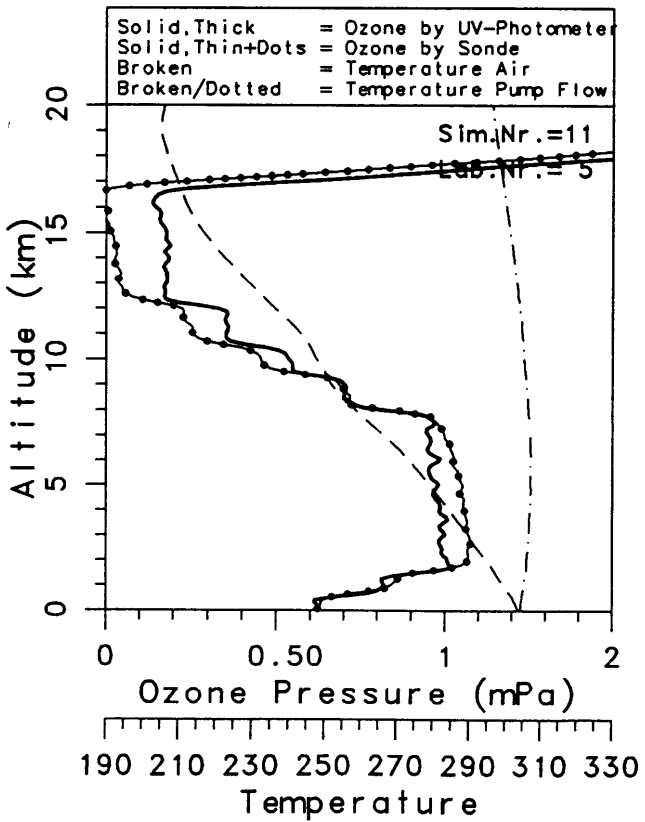
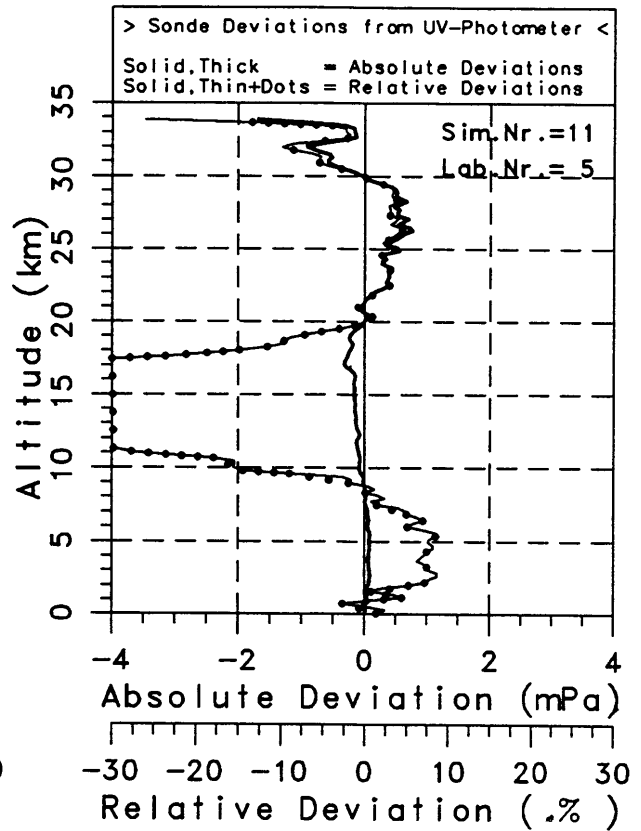
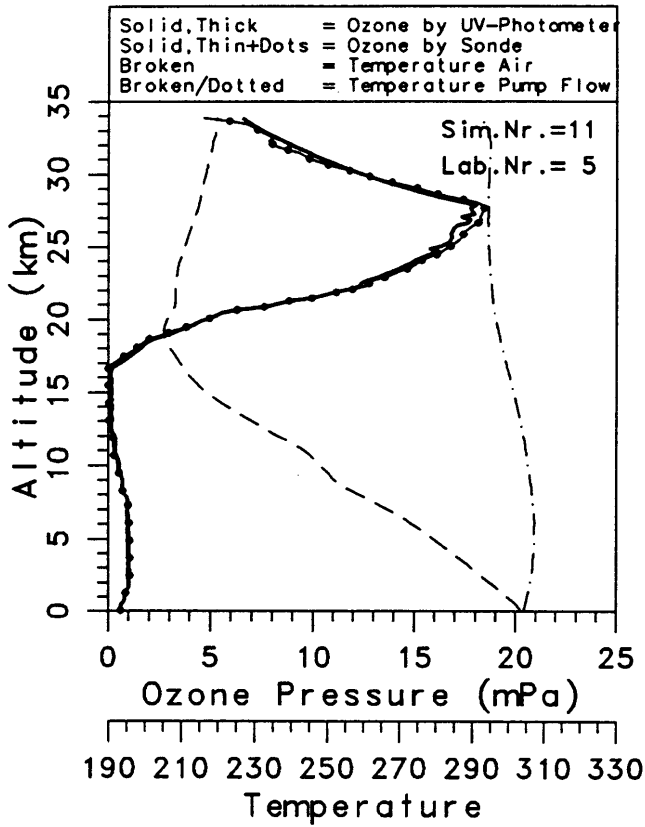

Sim.Exp.Nr. =11 Date = 05 March 1996

Type Profile = Tropics

Part.Lab.(6) = AES

Sonde = ECC/SPC-5A

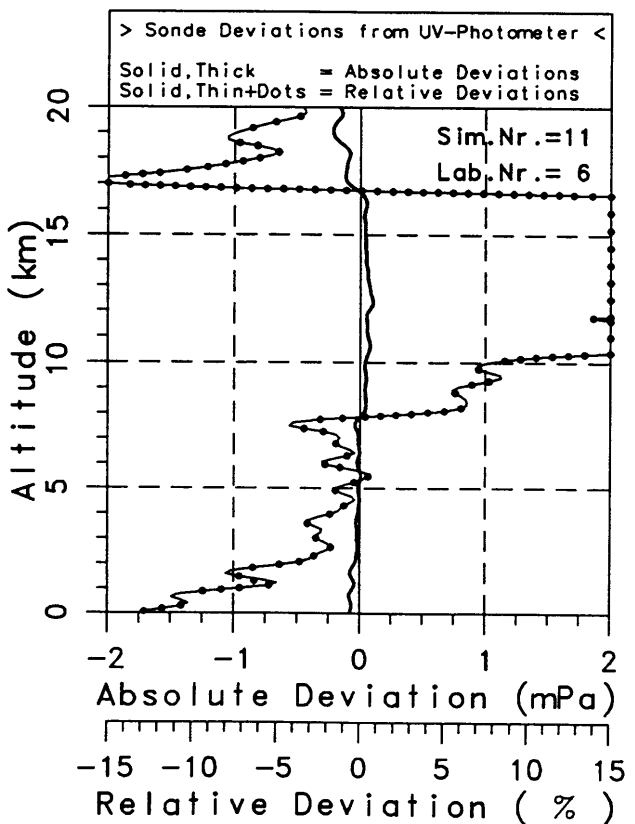
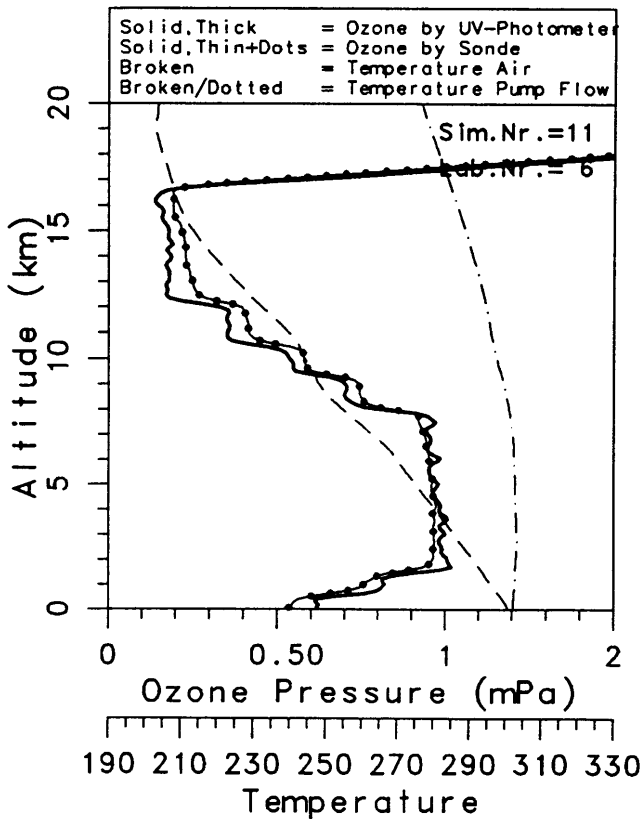
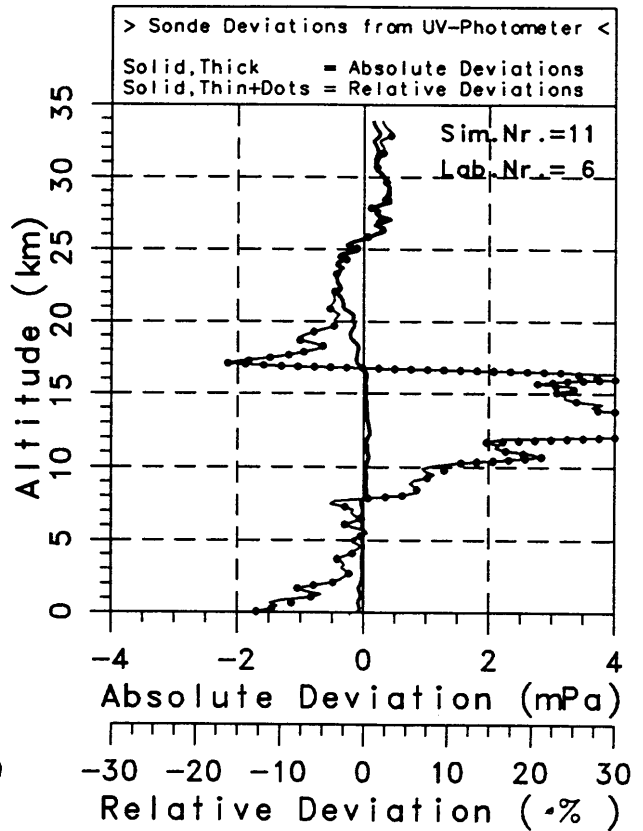
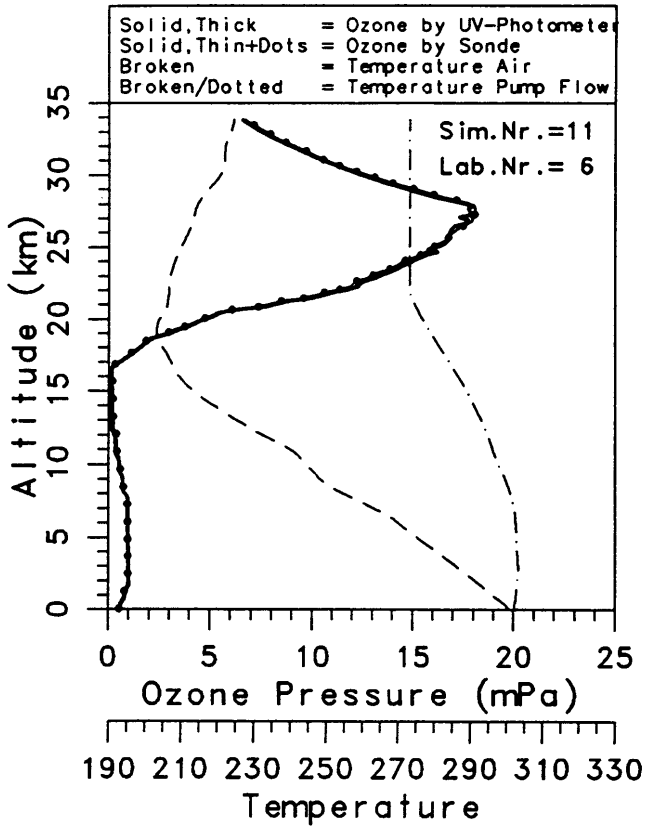

Sim.Exp.Nr. =11 Date = 05 March 1996

Type Profile = Tropics

Part.Lab.(7) = CNRS

Sonde = ECC/SPC-5A

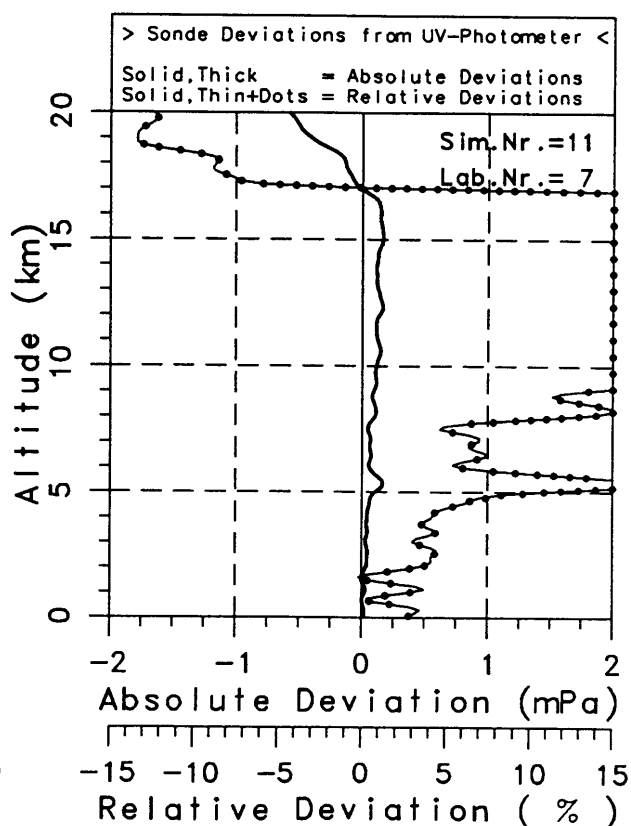
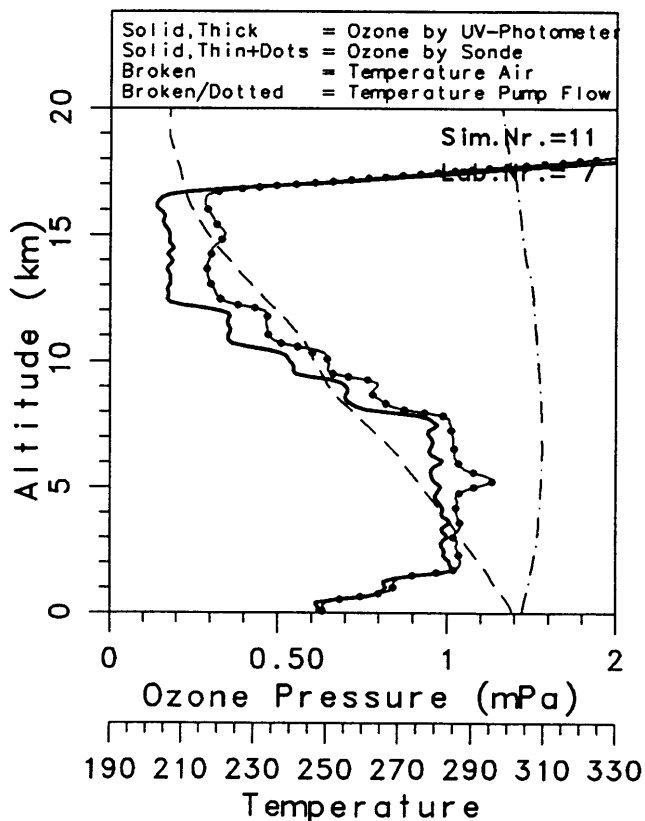
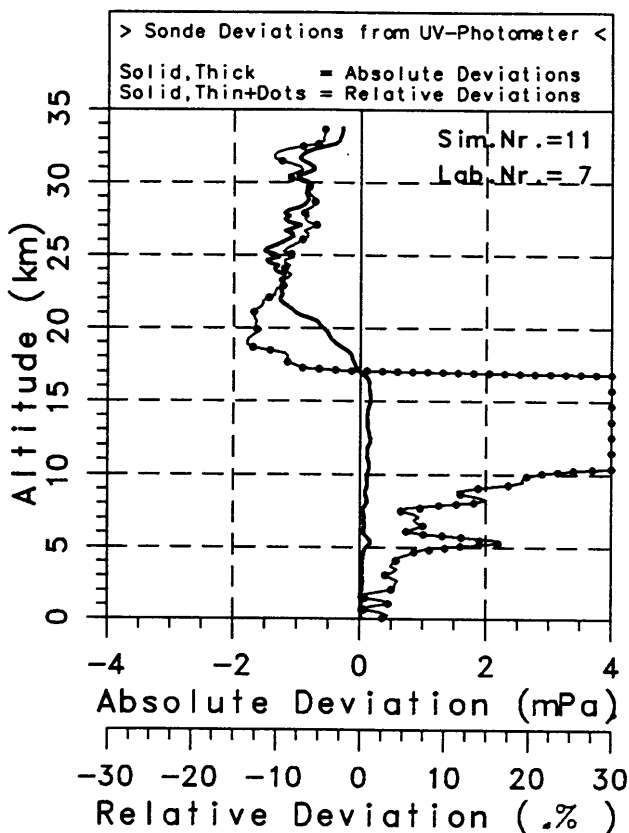
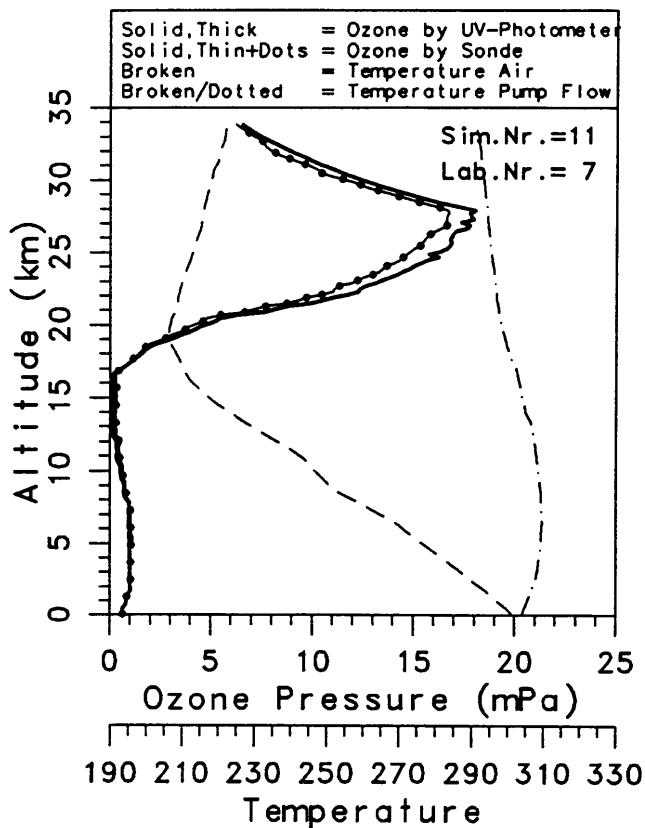

Sim.Exp.Nr. =11 Date = 05 March 1996

Type Profile = Tropics

Part.Lab.(8) = JMA

Sonde = KC79/JMA

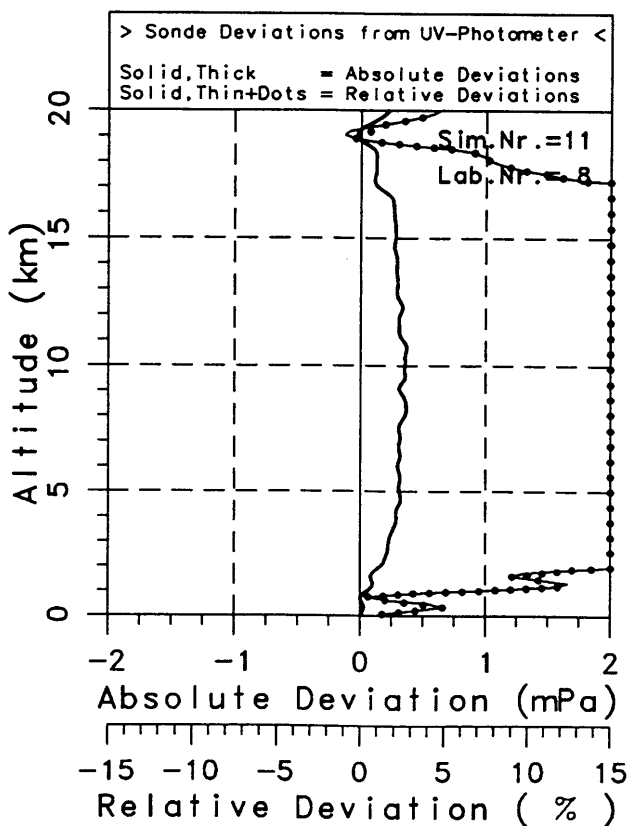
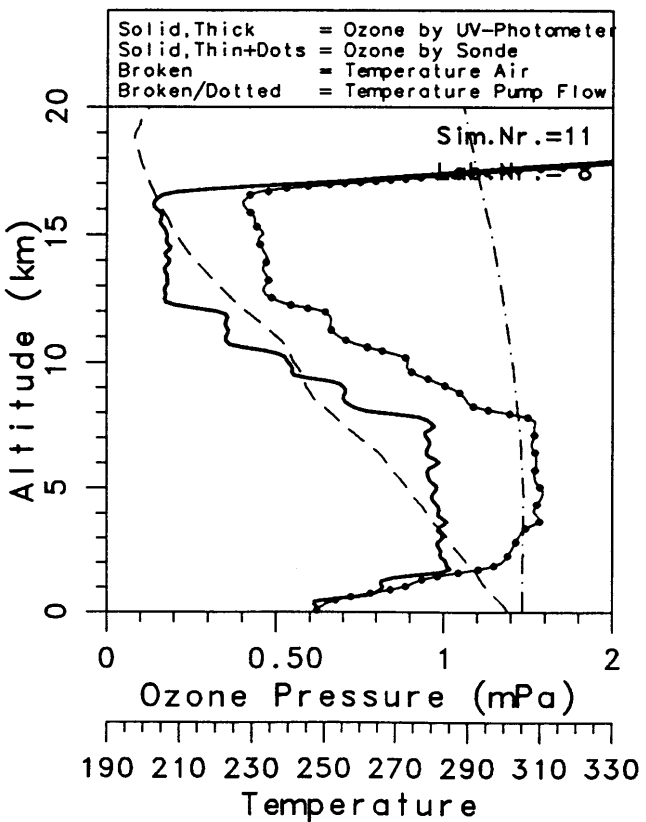
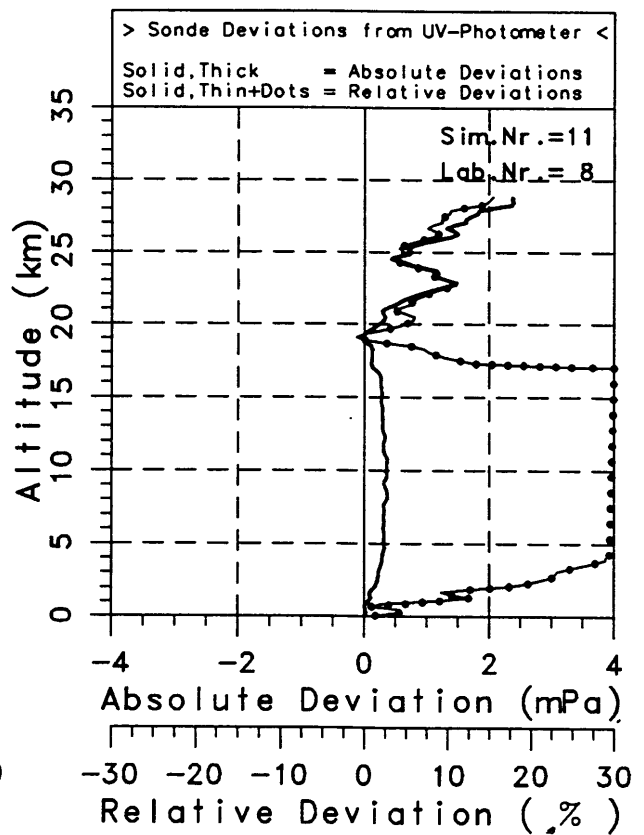
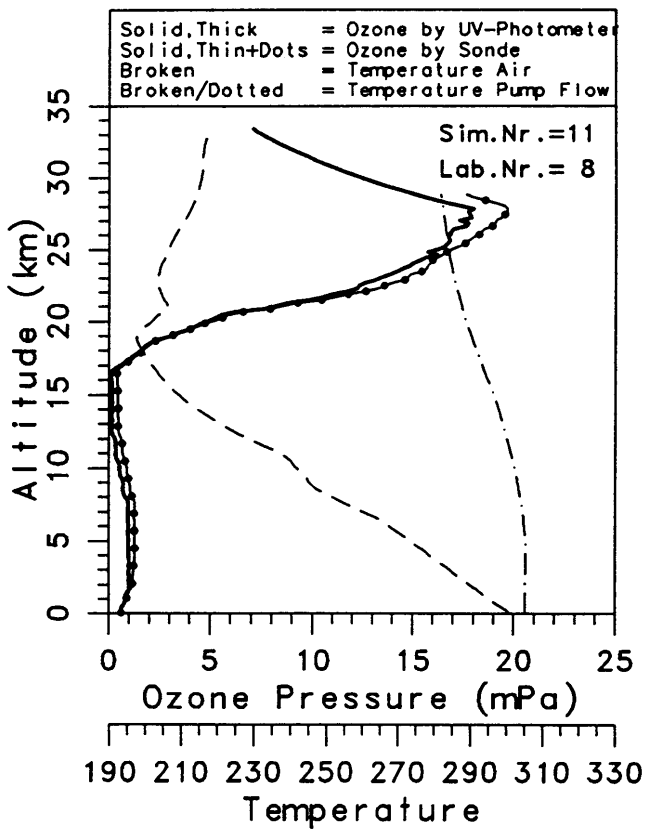

Sim.Exp.Nr. =12 Date = 06 March 1996

Type Profile = Mid Latitude

Part.Lab.(5) = ASP

Sonde = BM/ECC-Hybrid

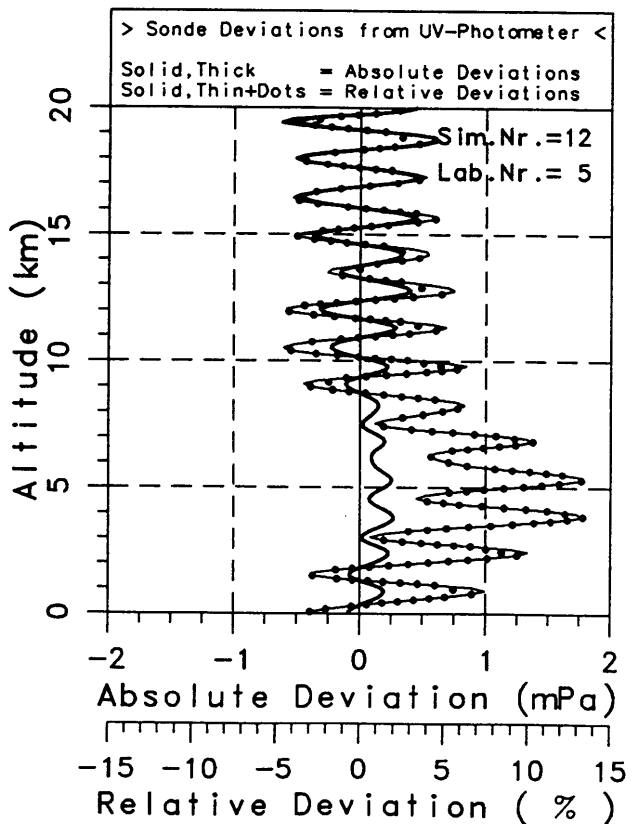
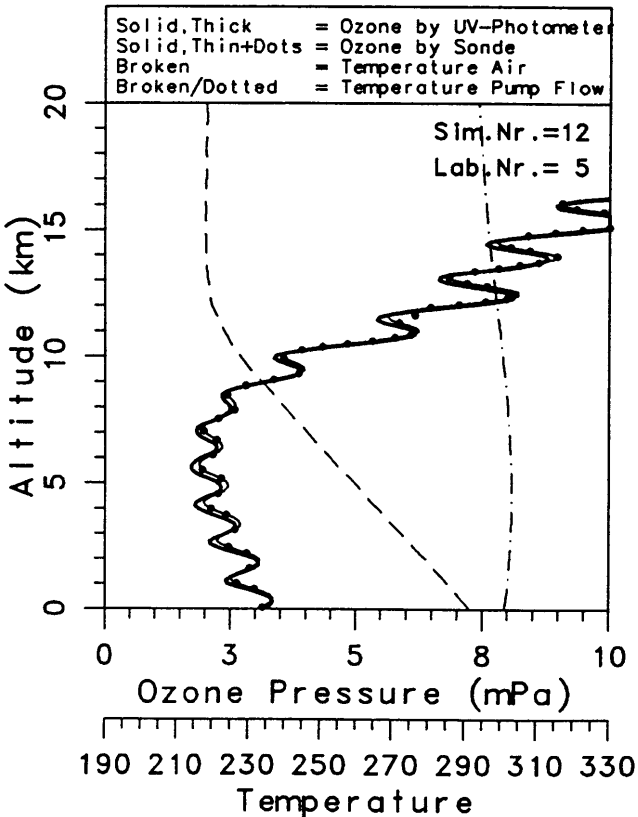
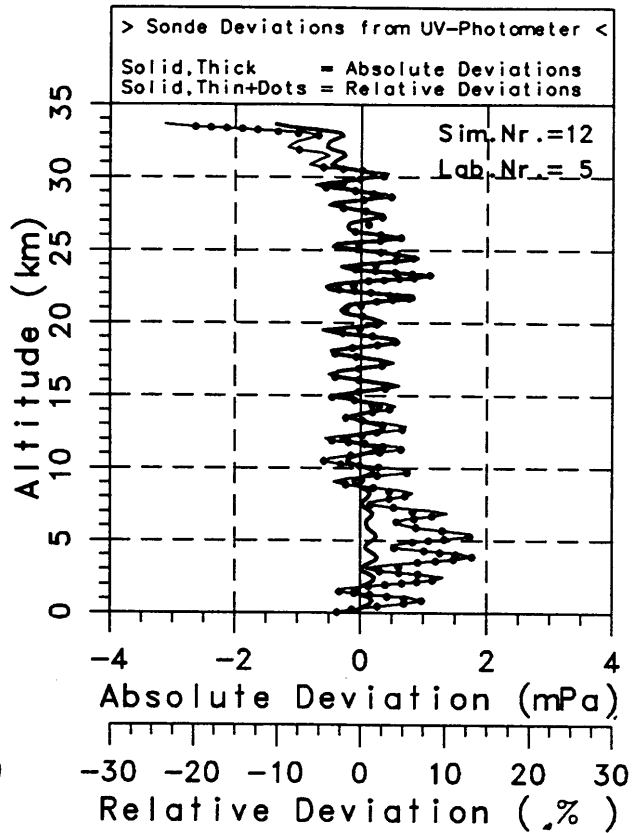
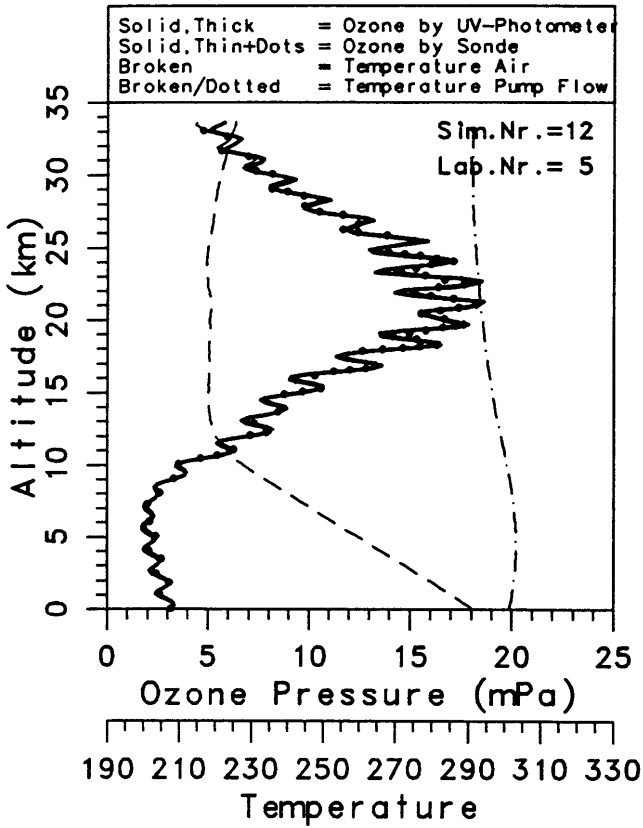

Sim.Exp.Nr. = 12 Date = 06 March 1996

Type Profile = Mid Latitude

Part.Lab.(6) = AES

Sonde = ECC/ENSCI-1Z

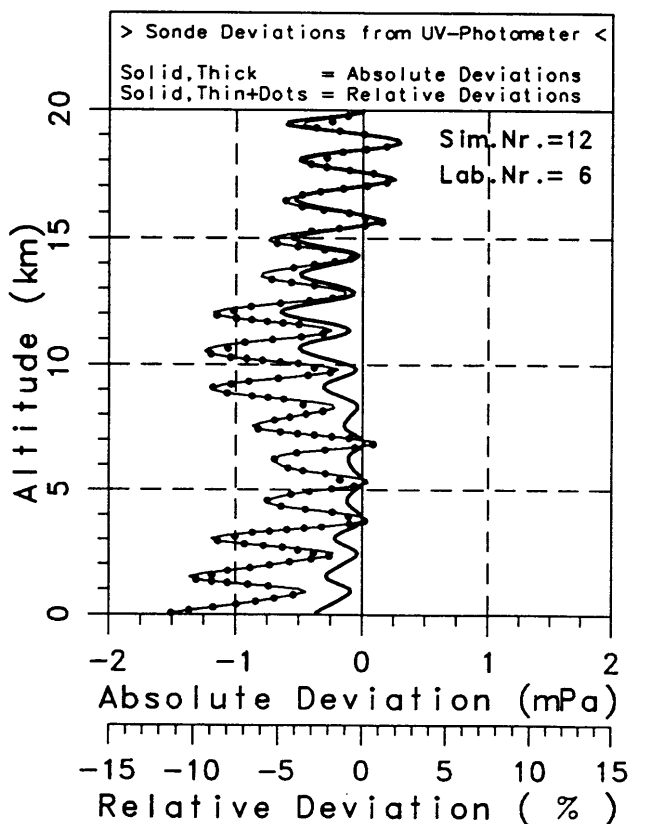
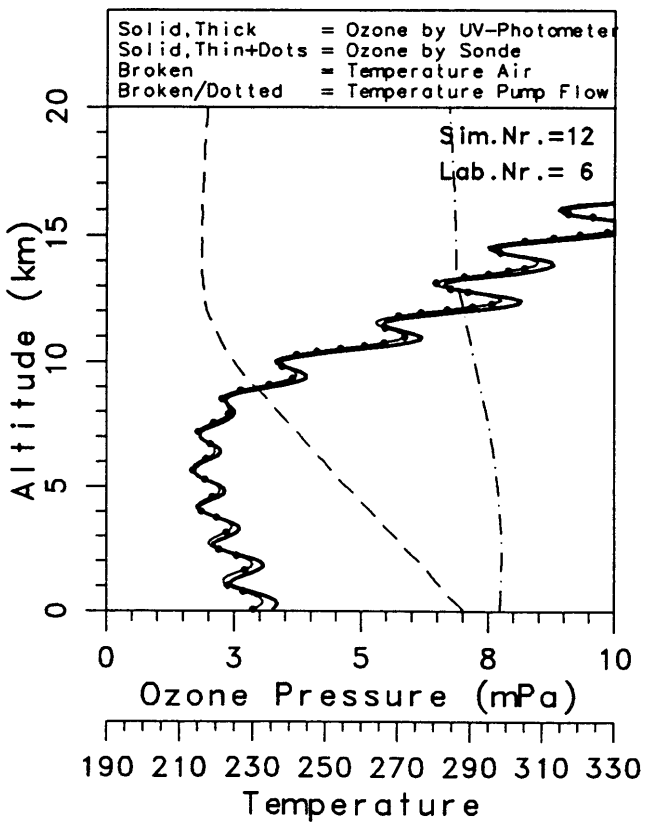
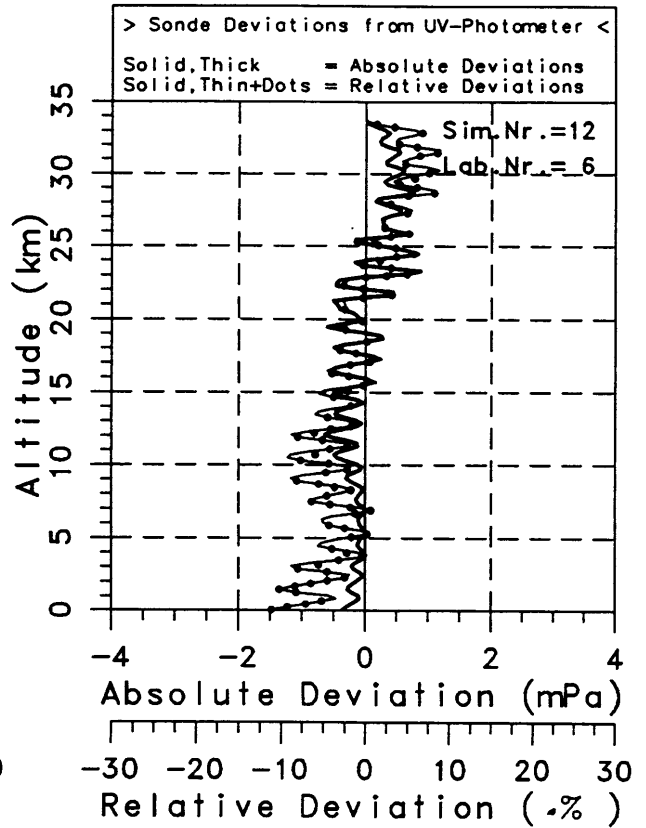
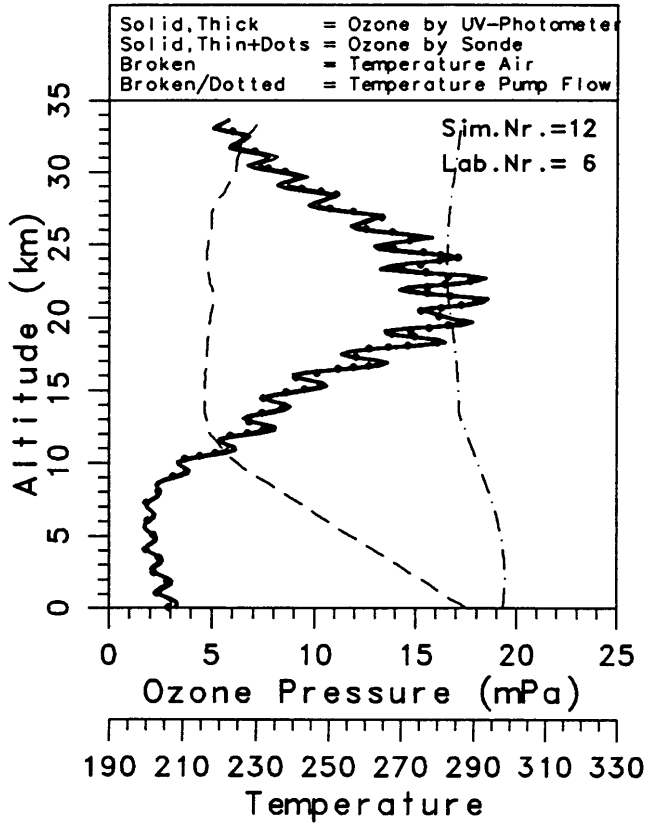

Sim. Exp. Nr. = 12 Date = 06 March 1996

Type Profile = Mid Latitude

Part. Lab. (7) = CNRS

Sonde = ECC/SPC-5A

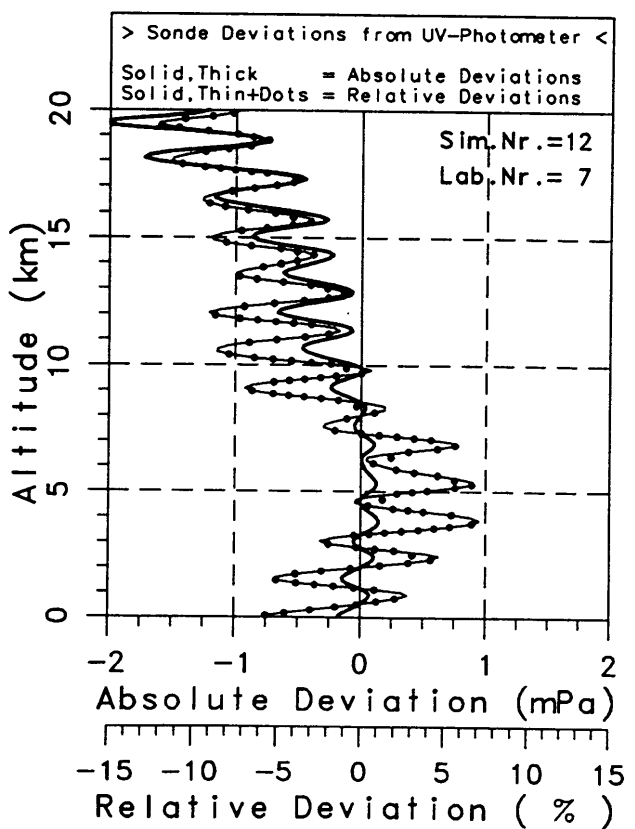
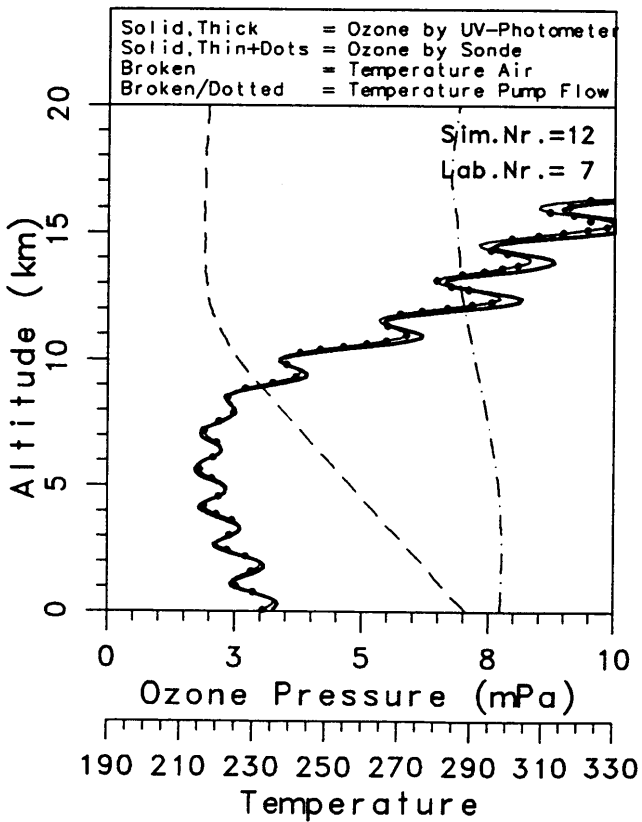
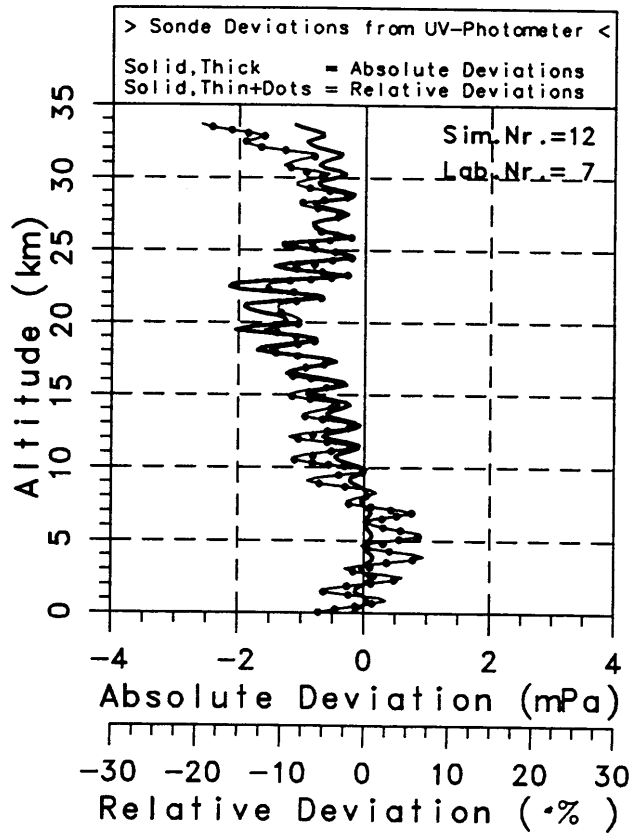
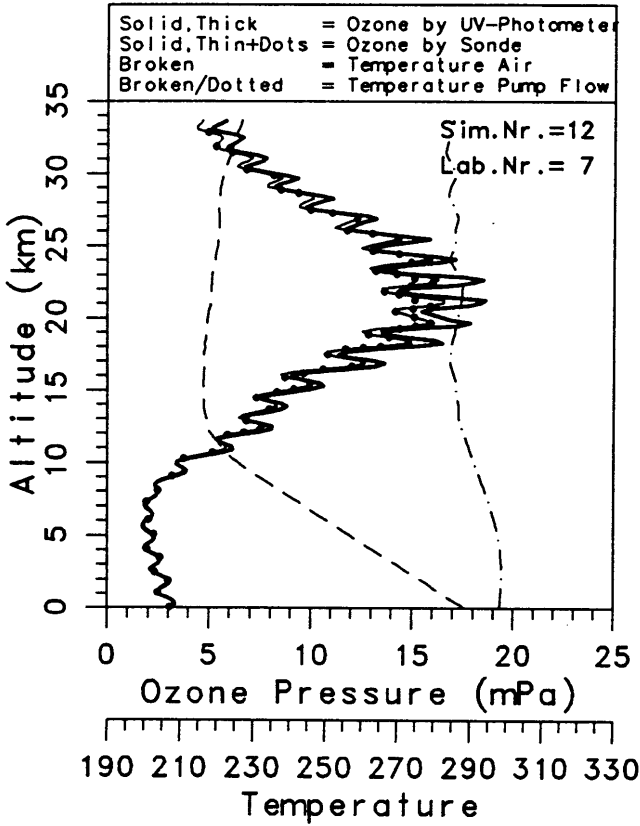

Sim.Exp.Nr. =12 Date = 06 March 1996

Type Profile = Mid Latitude

Part.Lab.(8) = JMA

Sonde = KC79/JMA

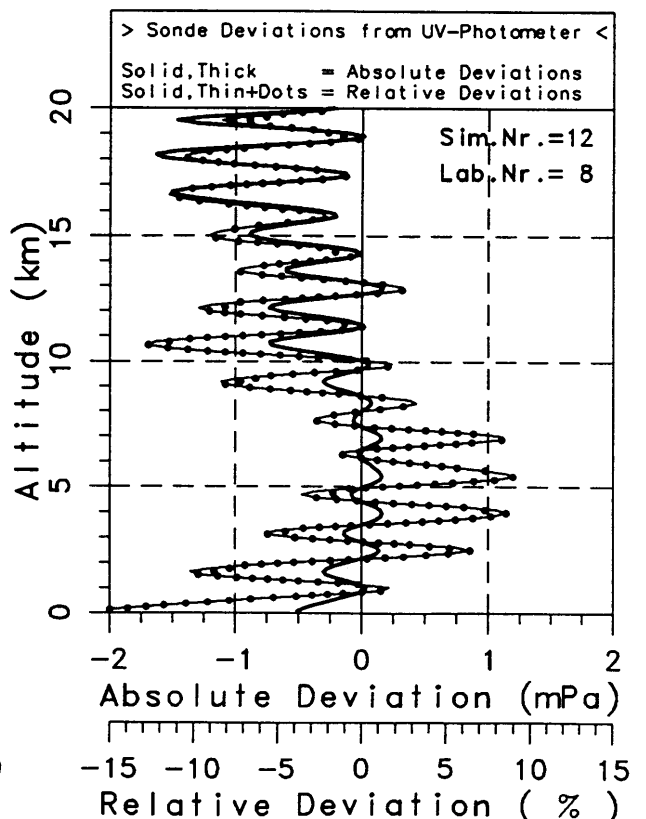
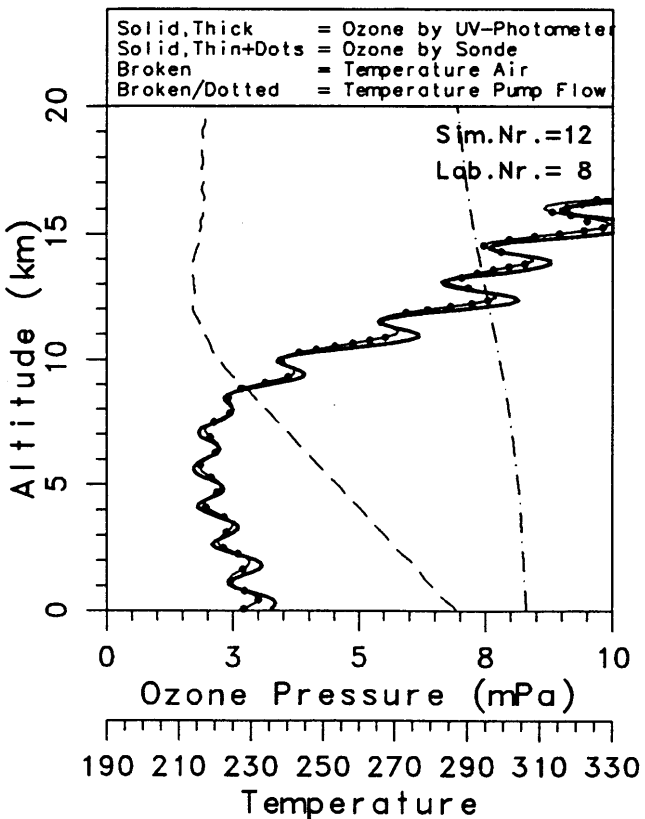
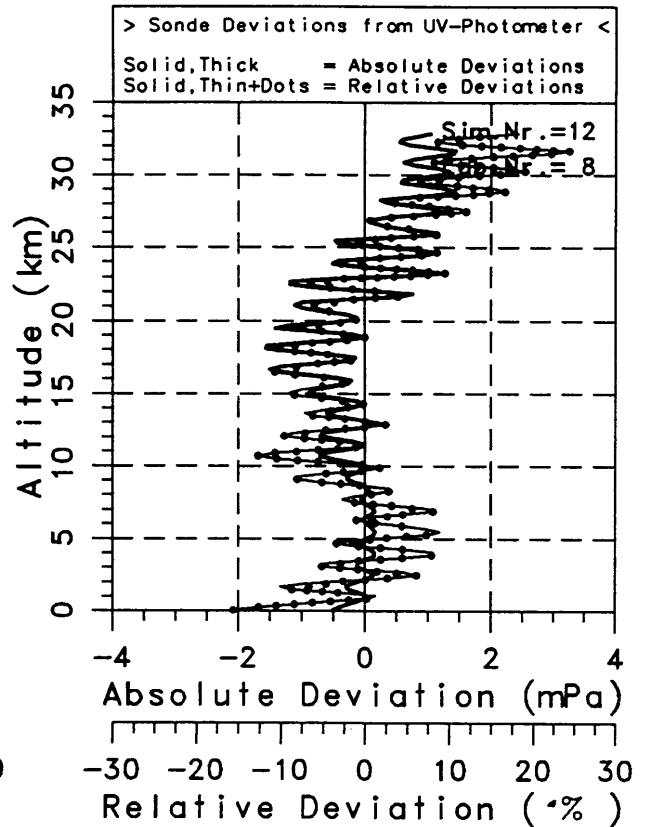
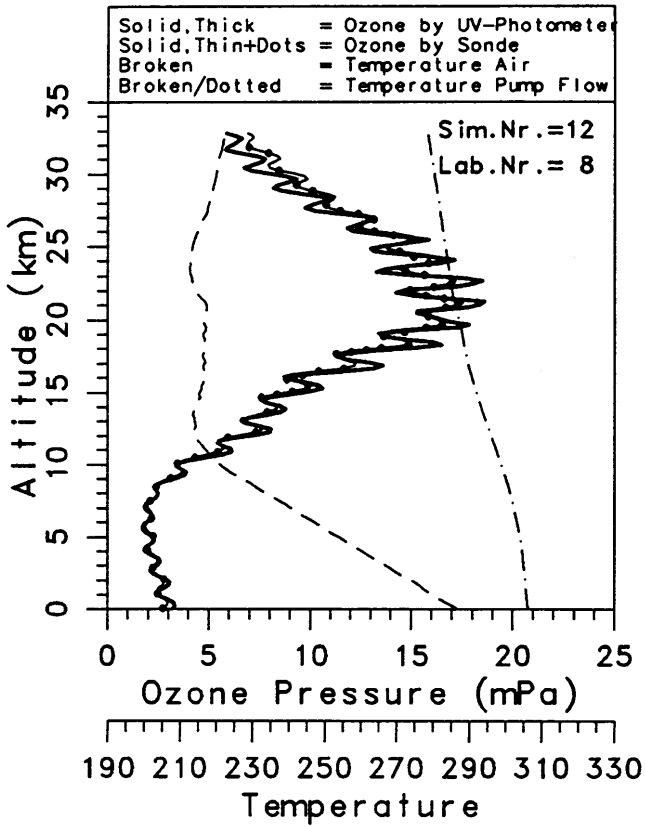

Appendix B

Specifications of JOSIE-Data

Appendix-B: Specifications of JOSIE-Data

The JOSIE-Data consists of data files (extension DS1) containing the results of the individual simulation runs for each participating sounding laboratory. The individual files are coded as follows:

- SIMiiiAj.DS1 = Name of the Output file for Ascent
 - SIMiiiBj.DS1 = Name of the Output file for Descent
- iii = Simulation-number
 A = Ascent
 B = Descent
 j = Number of the participating laboratory
 DS1 = Data set Version 1

DS1-File for each Participating Group

I.) Line No. 1-7 : Header

II.) Line No. 8 : Short names for individual data columns

III.) Individual data columns:

- | | | | |
|------|----|--|-----------|
| 1.) | A. | Record number | [Integer] |
| 2.) | B | Time (computer) | [sec.] |
| 3.) | C | Time (simulation) | [sec] |
| 4.) | D | Pressure air in ESC | [hPa] |
| 5.) | E | Temperature air in ESC | [K] |
| | | <i>(Note: Temperature measured in the testroom of the ESC)</i> | |
| 6.) | F | Temperature air at sample air intake | [K] |
| | | <i>(Note: Temperature measured at the sample air intake of each sonde individually)</i> | |
| 7.) | G | Altitude (simulated) | [km] |
| 8.) | H | Ozone pressure by UV-Photometer | [mPa] |
| 9.) | I | Ozone current of sonde (<u>RAW</u>) | [μA] |
| 10.) | J | Temperature inside sonde | [K] |
| 11.) | K | Ozone pressure by sonde (level: <u>RAW</u>) | [mPa] |
| 12.) | L | Ozone pressure by sonde (level: <u>COR</u>) | [mPa] |
| | | <i>(Note: All corrections included, but without Total O3 normalization)</i> | |
| 13.) | M | Ozone pressure by Sonde (level: <u>TOC</u>) | [mPa] |
| | | <i>(Note: All corrections: Included Total O3 normalization)</i> | |
| 14.) | N | Ozone column by Sonde | [DU] |
| | | <i>(Note: Integrated column of ozone by sonde calculated from ozone-pressure by sonde at COR-level, NO total ozone normalization included)</i> | |
| 15.) | O | Ozone column by UV-Photometer | [DU] |
| | | <i>(Note: Integrated column of ozone by UV-Photometer)</i> | |
| 16.) | P | Validity number code of data record | [Integer] |

Comments to DS1-File

- **Header:**

Prior to the profile data matrix there is a header of 8 lines containing the following information:

Line 1: File Name plus Ascent or Descent profile

Line 2: Simulation Experiment Number plus Date of the experiment

Line 3: Background Current of the ozone sonde [μA]

(determined during groundcheck prior to the simulation experiment)

Line 4: Flowrate of the air sampling pump [sccm/min]

(determined during groundcheck prior to the simulation experiment)

Line 5: Total Ozone Column obtained by ozone sonde [DU]

Line 6: Total Ozone Column obtained by UV-Photometer [DU]

Line 7: Total Ozone Normalization Factor

(Ratio of Total Ozone Columns by UV-Photometer and Ozone Sonde)

Line 8: Short names for the different columns of the profile data matrix

- **Time Scale: Actual day time and simulation time**

As independent and common time scale the actual day time recorded by the Data Acquisition System of the simulation facility is used for the processing of the JOSIE-data. Simultaneously to the system time there is supported a simulation time which is set to zero at the start of the simulation. The data were made equidistant in time with a time step of 5 seconds. The start and stop time of each simulation of ascent and descent respectively are listed in Table B-1

<i>Si-No.</i>	<i>Ascent Start</i>	<i>Ascent Stop</i>	<i>Descent Start</i>	<i>Descent Stop</i>
1	42839	50109	50109	57194
2	42962	50142	50142	57257
3	46883	54508	54508	62213
4	42673	51148	51148	58543
5	42265	49395	49395	56435
6	44558	51723	51723	58923
7	43683	50788	50788	57878
8	43446	50546	50546	57621
9	43380	50985	50985	58655
10	43980	50995	50995	58060
11	43440	50520	50520	57615
12	44702	51822	51822	58897

Table B-1: Start and stop time of each simulation of ascent and descent in seconds

- ***Correction levels ozone sonde data:***

A) **RAW-level:** Derived ozone pressure from measured sensor current according the conversion formulas submitted by the different stations. NO corrections were applied.

B) **COR-level:** Corrected data of ozone pressure derived from RAW-level data whereby all standard corrections are included with the exception of the total ozone normalization. Standard corrections like background, pump efficiency etc. are performed according the standard operating methods delivered by each station.

C) **TOC-level:** All corrections, included total ozone normalization

- ***Total ozone normalization:***

The integrated column of ozone measured by the UV-photometer during the simulation of the ascent or the descent of a sounding experiment serve as reference for the total ozone normalization. The total ozone normalization factor is defined as the ratio of the integrated columns of ozone obtained from the UV-photometer and the sonde respectively. For each sonde individually the integrated column of ozone by the UV-photometer is determined using the air temperature measured at the air sample intake of the sonde. Parts of erratic or missing data in the vertical profile measured by the sonde and/or the UV-photometer were discarded for the ozone column integrations. These specific parts are reported in the next two sections. No residuals of ozone were calculated.

- ***Missing Data from Data Acquisition System or UV-Photometer:***

Some small parts of the profiles obtained from the simulation experiments numbers 1, 3 and 4 are missing, caused to incidental failure of the data acquisition system (DAS) of the ESC.

The missing parts are the following:

- 1.) Simulation experiment No. 1:
 - a.) Time: 43600 - 43920 sec.
- 2.) Simulation Experiment No. 3:
 - a.) Time: 52480 - 52950 sec. (only UV-Photometer data are missing)
- 3.) Simulation Experiment No. 4:
 - a.) Time: 45480 - 45800 sec.
 - b.) Time: 49120 - 49370 sec.

These missing data were replaced by linear interpolated data over the erratic data interval and were excluded from total ozone column determinations, presented in columns N & O for the sonde and the UV-photometer respectively.

- ***Missing Data from Individual Sondes:***

- 1.) Simulation Experiment No. 1:
 - PG-1: Time: 49280 - 50109 (freezing of sensing solution)
 - PG-2: Time: 49475 - 50109 (freezing of sensing solution)
 - PG-4: Time: 46820 - 47070 (current/voltage converter out of range)
 - PG-4: Time: 48975 - 50109 (freezing of sensing solution)
- 2.) Simulation Experiment No. 3:
 - PG-1: Time: 50092 - 50142 (freezing of sensing solution)
 - PG-4: Time: 46883 - 48083 (erratic data acquisition)
- 3.) Simulation Experiment No. 6:
 - PG-1: Time: 51610 - 51723 (freezing of sensing solution)
- 4.) Simulation Experiment No. 7:
 - PG-5: Time: 49400 - 50788 (freezing of sensing solution)
 - PG-8: Time: 48350 - 50788 (JMA-Data System Blocked)
- 5.) Simulation Experiment No. 8:
 - PG-8: Time: 50390 - 50546 (JMA-Data System Stopped)
- 6.) Simulation Experiment No. 9:
 - PG-8: Time: 50310 - 50985 (JMA-Data System Stopped)
- 7.) Simulation Experiment No. 10:
 - PG-8: Time: 50570 - 50995 (JMA-Data System Stopped)
- 8.) Simulation Experiment No. 11:
 - PG-8: Time: 50390 - 50520 (JMA-Data System Stopped)
- 9.) Simulation Experiment No. 12:
 - PG-8: Time: 51650 - 51822 (JMA-Data System Stopped)

- ***Validity Code Number for Data Record:***

The validity code number is an integer with following specifications:

- Code Number 0 = Non valid data
 1 = Valid data
 2 = Limited valid data: UV-Photometer not valid
 3 = Limited valid data: Sonde data not valid

In the cases of Not Valid or Limited Valid the data are replaced by linear interpolated data over the non-valid data interval.

Appendix C

People Involved in JOSIE

Appendix C : People involved in JOSIE

JOSIE Scientific Steering Committee

DP. Herman G.J. Smit (Chairman)

Research Center Jülich (FZJ)
 Institute for Chemistry of the Polluted Atmosphere (ICG-2)
 P.O. Box 1913
 D-52425 Jülich , Germany
 Tel: (+)-49-2461-613290 Fax: (+)-49-2461-615346
 E-mail: h.smit@kfa-juelich.de

Dr. John Miller

World Meteorological Organization (WMO) - Environment Division
 41 Giuseppe Motta
 Case Postal No. 2300
 CH-1211 Geneva 2 , Switzerland
 Tel: (+)-41-22-7308240 Fax: (+)-41-22-7400984
 E-mail: john-milton.miller@itu.ch

Dr. Samuel J. Oltmans

NOAA-Climate Monitoring & Diagnostic Laboratory (CMDL)
 325 Broadway
 Boulder CO 80303-3328 , USA
 Tel: (+)-1-303-4976676 Fax: (+)-1-303-4976290
 E-mail: soltmans@cmdl.noaa.gov

JOSIE-Organizing Committee at World Calibration Facility for Ozone Sondes

Research Center Jülich: Institute for Chemistry of the Polluted Atmosphere (FZJ/ICG-2)

DP. Herman G.J. Smit (Coordinator / SOP's)

Ing. Wolfgang Sträter (Environmental Simulation Chamber)

Dr. Manfred Helten (Logistic / SOP's)

Daniela Ciupa (Data Processing)

Prof. Dr. Dieter Kley (Director Calibration Facility)

Referee JOSIE-Campaign:

Prof. Dr. Volker A. Mohnen

University at Albany , c/o Atmospheric Sciences Research Center
 100 Fuller Road
 Albany NY 12205 , USA
 Tel: (+)-1-518-442-3819 Fax: (+)-1-518-442-3867
 E-mail: vam@atmos.albany.edu

Participating Ozone Sounding Laboratories**Campaign Period I (5-16 February 1996)****Group Nr. 1: MOHp (Brewer-Mast ozone sonde with original pump)****Meteorologisches Observatorium Hohenpeissenberg (MOHp)**

Deutscher Wetterdienst DWD

Albin Schwaiger Weg 10

D-82383 Hohenpeissenberg , Germany

Participants:**DP. Hans Jürgen Claude** (Principal Investigator)**DP. Ulf Köhler****Martin Adelwart****Group Nr. 2: CMDL (ECC-ozone sonde)****NOAA Climate Monitoring & Diagnostic Laboratory (NOAA/CMDL)**

325 Broadway

Boulder CO 80303-3328 ,USA

Participants:**Dr. Bryan Johnson** (Principal Investigator)Tel: (+)-1-303-4976842 Fax: (+)-1-303-4976290 Email: bjohnson@cmdl.noaa.gov**Dr. Samuel J. Oltmans****Group Nr.3: FZJ (ECC-ozone sonde)****Research Center Jülich GmbH (FZJ)**

Institute for Chemistry of the Polluted Atmosphere (ICG-2)

P.O. Box 1913

D-52425 Jülich ,Germany

Participants:**Dr. Manfred Helten** (Principal Investigator)Tel.: (+)-49-2461-616745 Fax.: (+)-49-2461-615346 E-mail: m.helten@kfa-juelich.de**Ing. Wolfgang Sträter****Group Nr.4: IMD (Indian Ozone Sonde)****India Meteorological Department (IMD)**

Lodi Road

New Delhi - 110 003 , India

Participants:**Dr. S.K. Srivastav** (Principal Investigator)Tel. (+)-91-11-4611710 Fax.(+)-91-11-4699216 E-Mail: sks@imd.ernet.in**P.N. Mohanan**

Campaign Period II (26 February - 8 March1996)

Group Nr.5: ASP (*Hybride of Brewer-Mast ozone sensor with ECC-Teflon pump*)

Swiss Meteorological Institute/Aerologische Station Payerne (SMI/ASP)

CH-1530 Payerne , Switzerland

Participants:

Dr. Bruno Hoegger (Principal Investigator)

Tel: (+)-41-37-62-6228/6111 Fax: (+)-41-37-61-1194 Email: hoe@sap.sma.ch

Gilbert Levrat

Bertrand Henchoz

Alexandre Joye

Group Nr. 6: AES (*ECC-ozone sonde*)

Atmospheric Environment Service (AES) / Experimental Studies Division

4905 Dufferin Street

Downsview Ontario , Canada M3H 5T4

Participants:

Dr. James B. Kerr (Principal Investigator)

Tel: (+)-1-416-739-4626 Fax: (+)-1-416-739-4281 Email: jkerr@dow.on.doe.ca

David.W. Tarasick

Jonathan Davies

Group Nr. 7: CNRS (*ECC-ozone sonde*)

Centre Nationale de la Recherche Scientifique (CNRS)/Service d'Aeronomie)

Institut Pierre Simon Laplace (IPSL) / CNRS , Centre Universitaire

10/12 Avenue de l'Europe

78140 Velizy , France

Participants:

Dr. Claude Vialle (Principal Investigator)

Tel: (+)-33-1-3925-4779 Fax: (+)-33-1-392-54822 Email: Claude.Vialle@cetp.ipsl.fr

Gerard Velghe

Group Nr. 8: JMA (*Japanese KC79 Sonde*)

Japan Meteorological Agency (JMA)

Ozone Layer Monitoring Office , Aerological Division , Observations Department

1-3-4 Ohte-machi, Chiyoda-ku,

Tokyo 100 , Japan

Participants:

Dr. Masanori Shitamichi (Principal Investigator)

Tel: (+)-81-298-51-4126 Fax: (+)-81-298-51-5765 Email: mshitami@mri-jma.go.jp

Mr. Hiroshi Kaneko

Appendix D

Formal Agreement of JOSIE

JOSIE , Jülich Ozone Sonde Intercomparison Experiment

5 - 16 Febr. 1996 and 26 Febr. - 8 March. 1996

(Sponsors: FZ-Jülich, QA/SAC-Germany, WMO/GAW)

Formal Agreement

We, the principal investigator

and co-workers

.....

.....

sign this protocol for the JOSIE campaign. The principal investigator and all members of his or her group agree

- to participate in the campaign
- to abide by the rules, formulated under paragraph 2.3 (Strategy of JOSIE) in the JOSIE-Planning Report (Version 2.0 , 1 February , 1996), agreed by the group before the start of the campaign
- to observe the instructions of the organizer during the intercomparison campaign, including any instruction to cease measurement
- to adhere to general safety regulations for personnel, apparatus, materials, and motor vehicles which are established for the site and buildings or may be introduced by the organizer
- to provide preliminary and final data sets to the database, established by the organizer, to the agreed schedules, irrespective of the investigator's own view of the quality of the data

to have only access to the entire database of JOSIE after signing a data protocol defining rights and duties of data usage

Location

Date.....

.....

Signature (PI)

.....

Signature (Co-worker)

.....

Signature (Co-worker)



Appendix E

Data Protocol of JOSIE

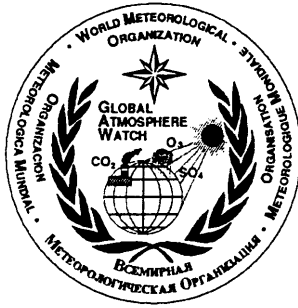

JOSIE

Jülich Ozone Sonde Intercomparison Experiment

5 - 16 Febr. 1996 and 26 Febr. - 8 Mar. 1996

(Sponsors: FZ-Jülich, QA/SAC Germany, WMO)

DATA PROTOCOL

The aims of the protocol are :

- to encourage rapid dissemination of the scientific results from JOSIE
- to uphold the rights of the individual scientists
- to have all involved researchers treated equitably.

These aims conflict at times, and it is hoped that the provisions of the protocol resolve these conflicts fairly. It is recognized that this cannot always be achieved to everyone's complete satisfaction; there are bound to be cases where individual interests clash with those of the program. The two cases which we hope to avoid are the hoarding and poaching of data. To try to meet these aims, all Principal Investigators, in accordance with and on behalf of their co-investigators, must sign that they will abide the following conditions.

A. MEASUREMENTS

- i) Data must be made available to other JOSIE scientists as soon as possible, as outlined in the JOSIE-Planning Report (Version 2.0, 1 February 1996). There are 2 advantages to quick release : a) planning of the future development of the program can be greatly improved, and b) scientific evaluation of the data can occur in a timely manner. Measurements, as preliminary values, should be made available as soon as possible.
- ii) Any corrections/amendments to the preliminary data should be announced as soon as possible.
- iii) It is the Principal Investigator's responsibility to ensure that the data used in publications are the best available at that time.
- iv) The Principal Investigators and their co-investigators agree to have access to the data contingent upon the following conditions : a) statement of scientific purpose from the party requesting the information; b) assurance of non-disclosure of data to other third parties; c) confirmation of use of the data for scientific information only.



JOSIE

Jülich Ozone Sonde Intercomparison Experiment

5 - 16 Febr. 1996 and 26 Febr. - 8 Mar. 1996

(Sponsors: FZ-Jülich, QA/SAC Germany, WMO)

B. GENERAL

- i) Following the opening of the data base to the scientific community, various co-investigators could associate with the JOSIE evaluation phase, working in connection with relevant PI's. All scientists involved in JOSIE Program are to have equal and complete access to measurements and model results produced during JOSIE Program.
- ii) If measurements/model results from other research groups within JOSIE are used in a publication, joint authorship must be offered.
- iii) Each Principal Investigator has the right to refuse to allow his work, whether measurement or calculation, to be used in another publication prior to his publication of that work.
- iv) The responsibility for the method with which data and model results are disseminated will rest with the central data bank (FZ-Jülich) and the JOSIE Steering Committee. Access to the data bank is granted only after having signed this protocol.
- v) Publication of results in the scientific literature is encouraged at any time during and after JOSIE Program, as long as conditions ii) and iii) are met.
- vi) Final versions of data should be sent to FZ-Jülich data bank by all JOSIE working groups as soon as validated. The data files should be in the JOSIE format, to be fixed by the Pi's.

C. PRINCIPAL INVESTIGATORS

Herman G.J. Smit	Research Center Juelich (FZ-Juelich)
Hans Claude	Met. Obs. Hohenpeissenberg (MOHP)
Bryan Johnson	NOAA/CMDL (Boulder)
Manfred Helten	Research Center Juelich (FZ-Juelich)
S.K. Srivastav	Indian. Meteorological. Dep. (IMD)
Bruno Hoegger	Aerologische. Station Payerne (ASP)
James B. Kerr	Atmospheric Environment Service (AES)
Claude Vialle	Observatoire Haut de Provence (OHP)
Masanori Shitamichi	Japan Meteorological Agency (JMA)



JOSIE

Jülich Ozone Sonde Intercomparison Experiment

5 - 16 Febr. 1996 and 26 Febr. - 8 Mar. 1996

(Sponsors: FZ-Jülich, QA/SAC Germany, WMO)

The undersigned agrees to the conditions of this data protocol.

Institution :

Address :

Name(s) of scientist(s), acting as Co-investigator(s) :

Associated to PI :

Date :

Signature:

Stamp of Institution:

Please return to :

Send copy to :

JOSIE Secretariat

c/o Herman Smit
Forschungszentrum Juelich GmbH
ICG-2
Postfach 1913
D-52425 Juelich
(GERMANY)

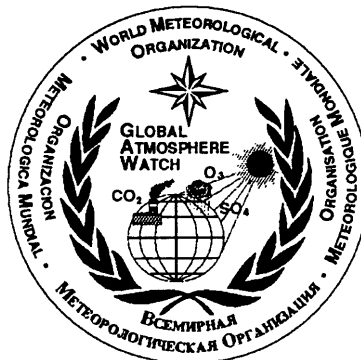

WMO

c/o John M. Miller
Environment Division
41 Giuseppe Motta
Case Postal No. 2300
CH-1211 Geneva 2
(SWITZERLAND)